



DCS GUIDE L-39ZA ALBATROS

LAST UPDATED: 05/05/2016

By Chuck

TABLE OF CONTENT

- PART 1 – INTRODUCTION
- PART 2 – CONTROLS SETUP
- PART 3 – COCKPIT & GAUGES
- PART 4 – START-UP PROCEDURE
- PART 5 – TAKEOFF
- PART 6 – LANDING
- PART 7 – ENGINE MANAGEMENT
- PART 8 – FLIGHT CHARACTERISTICS

- PART 9 – WEAPONS & ARMAMENT
- PART 10 – RADIO TUTORIAL
- PART 11 – NAVIGATION & ILS LANDING
- PART 12 – AEROBATIC FLYING
- PART 13 – TRAINING & FAILURE SIMULATION
- PART 14 – OTHER RESOURCES



With over 3,000 aircraft produced, the L-39 Albatros has become one of the most popular and widespread trainer aircraft in the world. Developed in Czechoslovakia by Aero Vodochody, it was designed during the 1960s as a replacement for the Aero L-29 Delfin as a principal training aircraft. The Albatros has the distinction of being the first of the second-generation jet trainers to be produced, as well as being the first trainer aircraft to be equipped with a turbofan powerplant.

Designed to be a cost-effective trainer aircraft, the L-39 was also capable of performing ground attack missions. For operational flexibility, simplicity, and affordability, the majority of onboard systems have been simplified to avoid incurring high levels of maintenance, as well as to minimize damage caused by mishandling when flown by inexperienced air crew. It could be readily flown from austere airstrips such as frozen lakebeds, enabled through the rugged design of the landing gear and favourable low landing speeds. The aircraft's flying qualities are reportedly simple, which is made easier by way of a rapid throttle response, making it easier for students who had never previously flown before to successfully control.

There are two variants of the L-39 in DCS: the L-39C training variant (C for Cvičná – training) and the L-39ZA Light Combat variant (Z for Zbraně – weapons). This guide is focused on the L-39ZA since it has better combat capabilities while retaining the trainer capabilities of the L-39C. Being the first DCS module that is “multicrew-capable” (meaning that two players can sit in the same plane), the Albatros is a perfect platform to learn the basics of instrument flying. It is also a great aircraft to perform aerobatic flying and this nimble czech plane is prized by aerobatic teams like the french **Breitling** Jet Team, the american **Patriots** Jet Team and the russian **Russ** Aerobatic Team.

While newer versions are now replacing older L-39s in service, thousands remain in active service as trainers, and many are finding new homes with private warbird owners all over the world. It has been claimed that the L-39's desirability stems from the fact that it is "the only available second-generation jet trainer". This trend is particularly evident in the United States, where their \$200,000–\$300,000 price puts them in range of moderately wealthy pilots looking for a fast, agile personal jet. Their popularity led to a purely L-39 Jet class being introduced at the Reno Air Races in 2002, though it has since been expanded to include other, similar aircraft.

Despite being initially underwhelmed by the “trainer” aspect of the L-39 (after all, this is no Su-27 or F-15), this jet rapidly grew on me and helped me learn a tremendous amount of things about flying. Unless your name is Chuck Yeager, the Albatros will teach you much more than you’d expect, I guarantee it. Being a good “virtual” pilot does not necessarily equate to getting kills online... it also means that you have a thorough understanding of the inner workings of aircraft instruments and navigation systems.

The L-39 is the embodiment of my philosophy about flight simulators: **ANY** aircraft can be enjoyable to fly if you give it a chance.

CONTROLS SETUP

BIND THE FOLLOWING AXES:

- PITCH (DEADZONE AT 0, SATURATION X AT 100, SATURATION Y AT 100, CURVATURE AT 0)
- ROLL (DEADZONE AT 0, SATURATION X AT 100, SATURATION Y AT 100, CURVATURE AT 0)
- RUDDER (DEADZONE AT 0, SATURATION X AT 100, SATURATION Y AT 100, CURVATURE AT 0)
- THRUST – THROTTLE CONTROLS ENGINE RPM

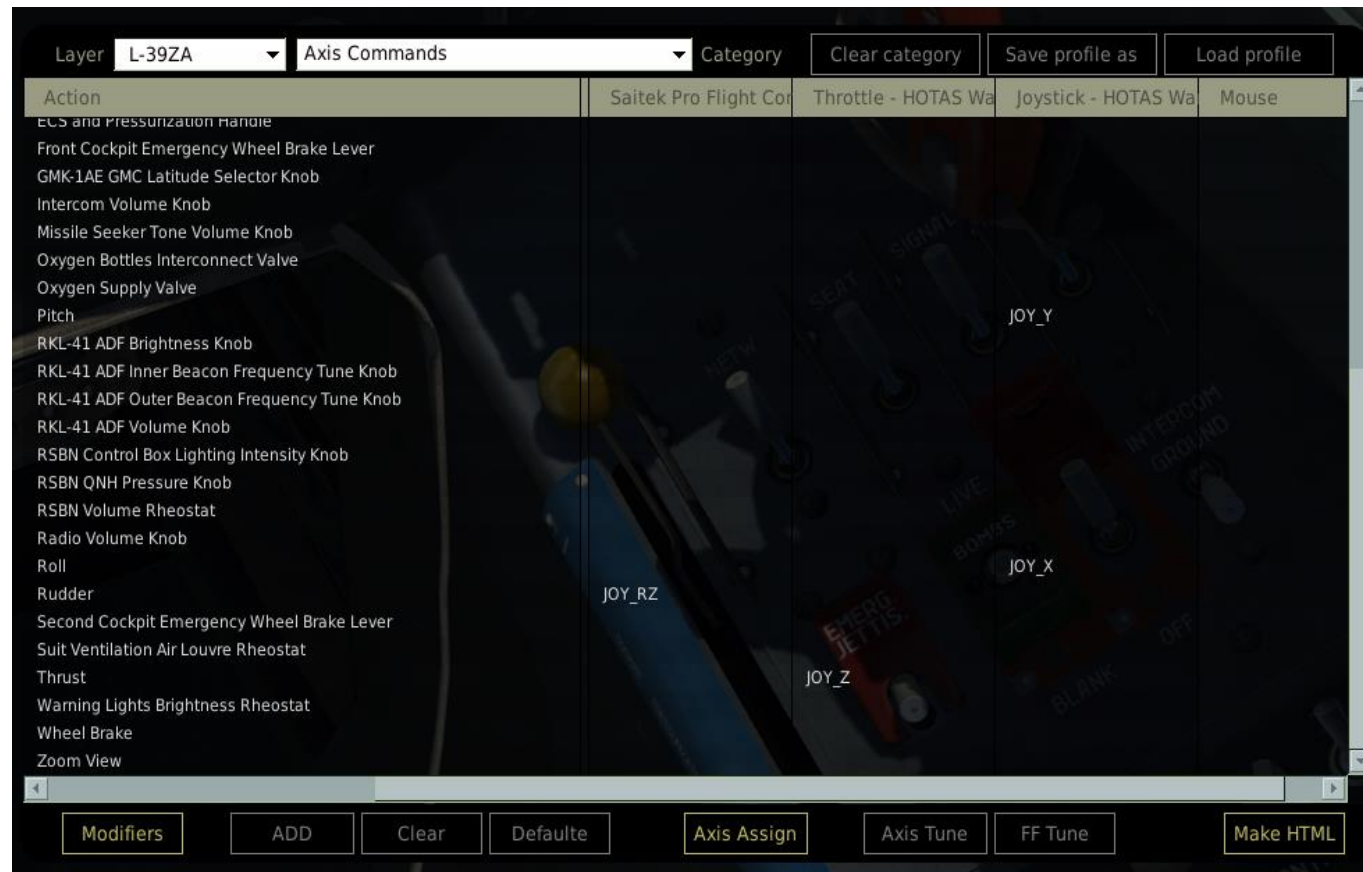

CONTROLS SETUP

ASSIGNING PROPER AXIS IS IMPORTANT. HERE ARE A COUPLE OF TIPS.

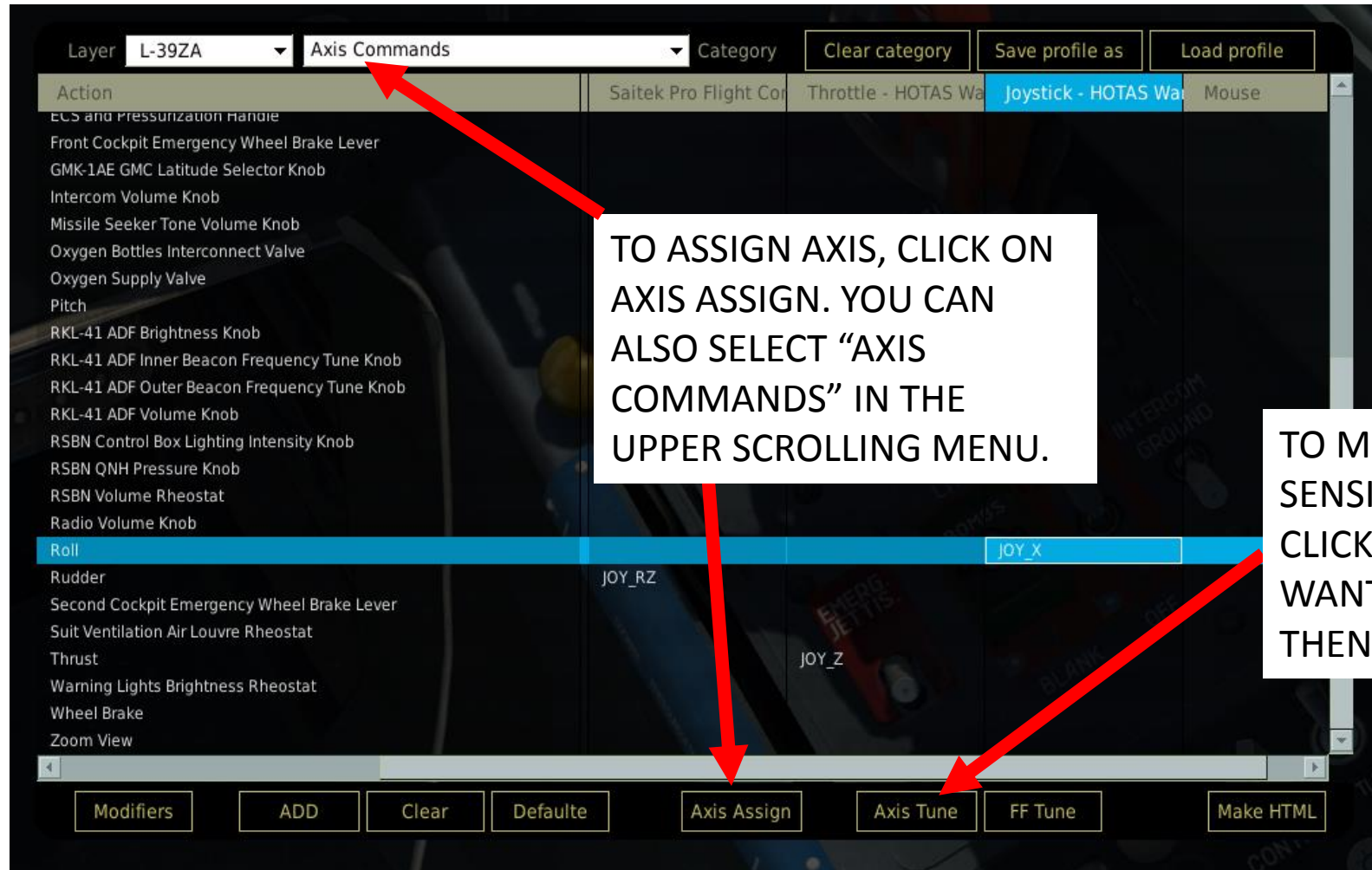

TO ASSIGN AXIS, CLICK ON AXIS ASSIGN. YOU CAN ALSO SELECT "AXIS COMMANDS" IN THE UPPER SCROLLING MENU.

TO MODIFY CURVES AND SENSITIVITIES OF AXES, CLICK ON THE AXIS YOU WANT TO MODIFY AND THEN CLICK AXIS TUNE

PART 2 – CONTROLS SETUP

WHAT YOU NEED MAPPED

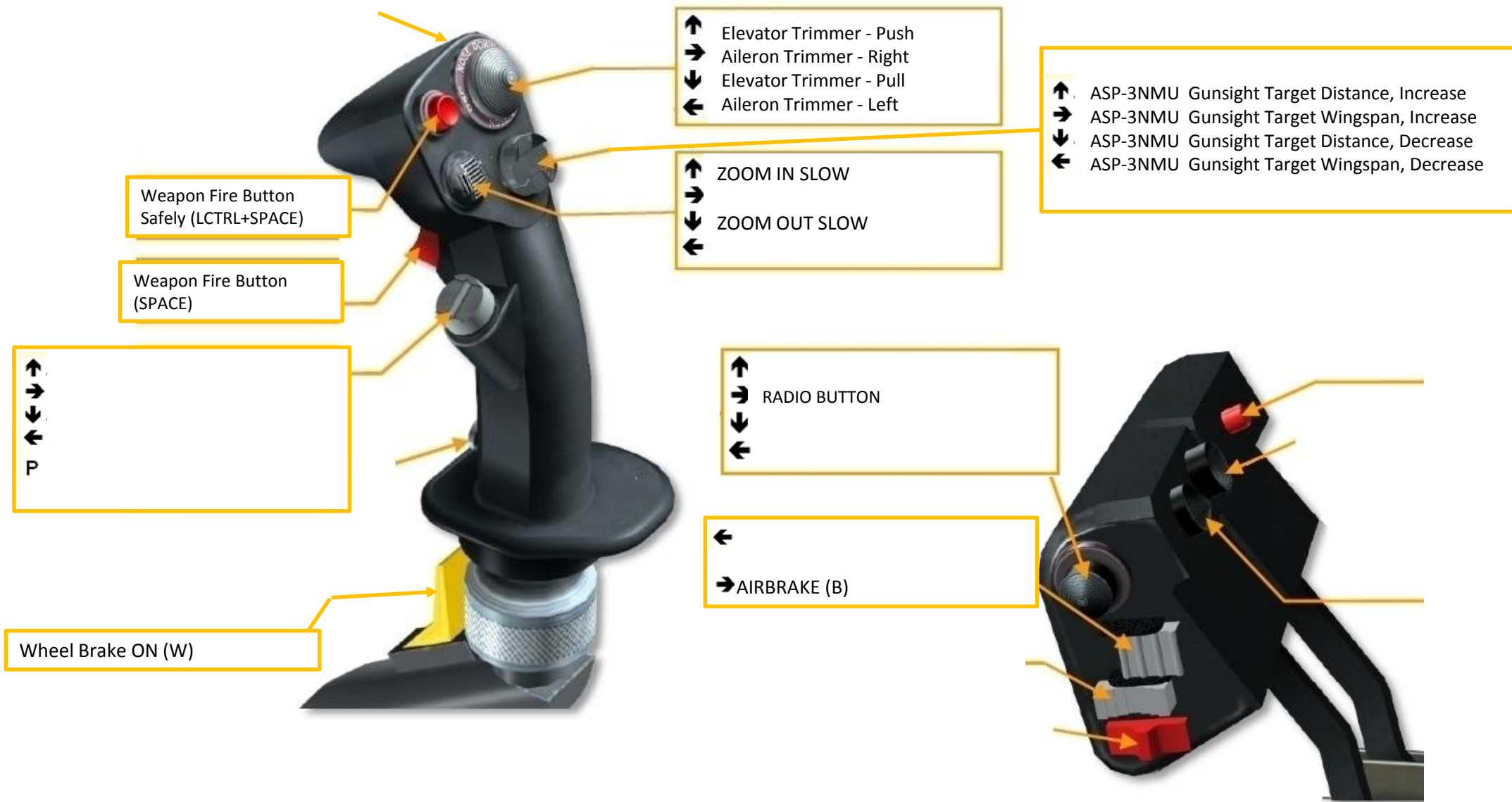

PART 3 – COCKPIT & GAUGES



L-39C
C for Cvičná – Training
Trainer Variant
2 x Pylons

L-39ZA
Z for Zbraně – Weapons
Attack Variant
4 x Pylons
1 x Cannon

PART 3 – COCKPIT & GAUGES

L-39ZA

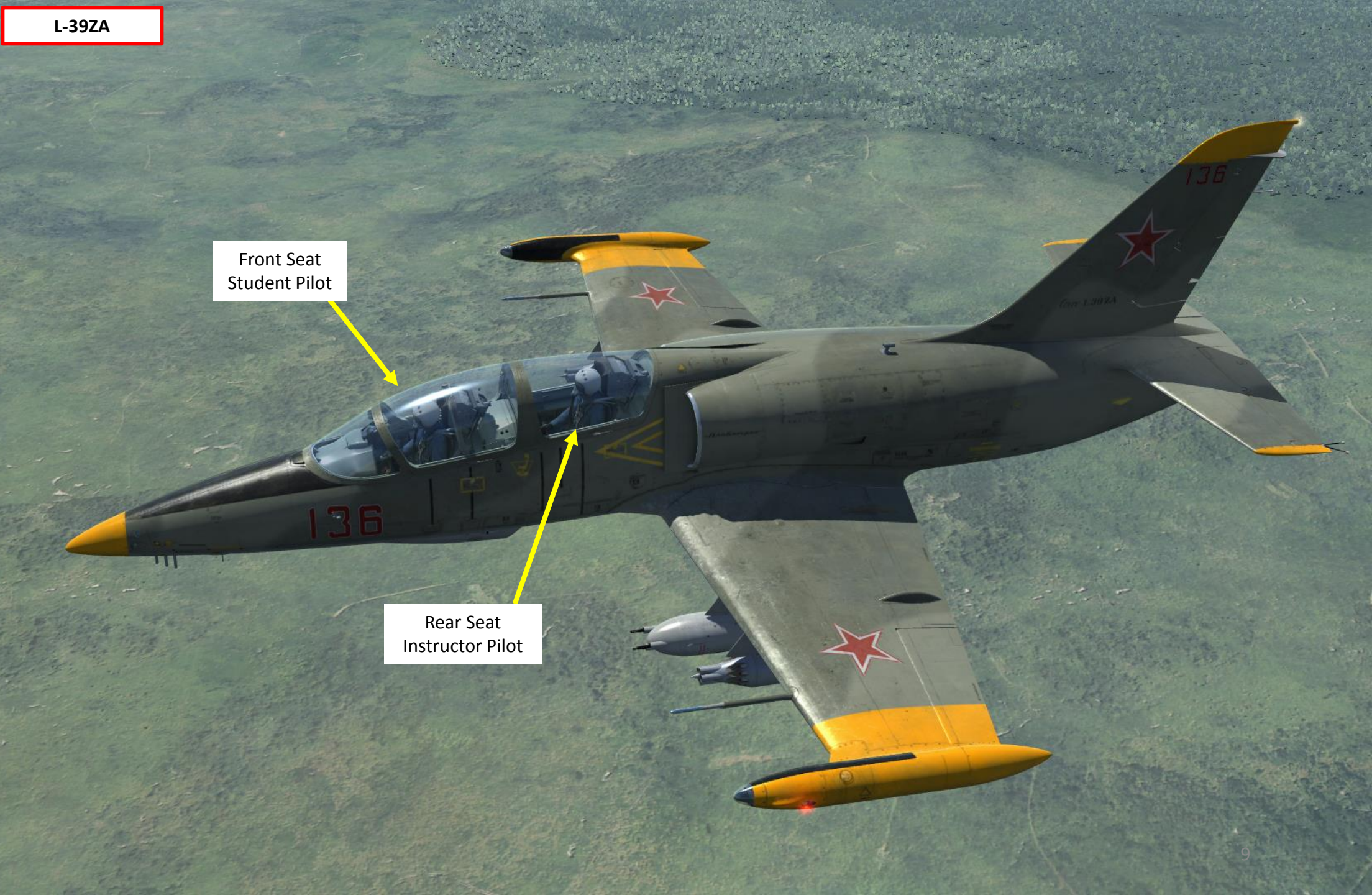

Front Seat
Student Pilot

Rear Seat
Instructor Pilot

PART 3 – COCKPIT & GAUGES

L-39ZA

FRONT COCKPIT



PART 3 – COCKPIT & GAUGES

L-39ZA

FRONT COCKPIT

Circuit Breakers: UP=ON/DOWN=OFF

- 1: Air Conditioning
- 2: Anti-Ice System
- 3: Stand-by (Left) Pitot Tube
- 4: Main (Right) Pitot Tube
- 5: PT-500C Inverter
- 6: ARK - RKL-41 ADF
- 7: SRO-2M IFF transponder
- 8: Seat Helmet

RT-12 JPT Regulator (EGT Limiter) Power Switch
UP=ON/DOWN=OFF

Circuit Breakers: UP=ON/DOWN=OFF

- 9: U/C Balance (aileron & elevator trimmer, landing gear and flaps indications)
- 10: CONTR (flaps, brake and airbrake control)
- 11: SIGN (indicator lamps on front cockpit)
- 12: Navigation lights hand lamp (floodlights + nav lights)
- 13: Search lights portside
- 14: Search lights starboard
- 15: Cockpit lighting – red floodlights
- 16: Cockpit lighting – white floodlights

Circuit Breakers: UP=ON/DOWN=OFF

- 17: Engine starting Panel
- 18: Engine fuel pump
- 19: Engine Ignition CB #1
- 20: Engine Ignition CB #2
- 21: SPT-40 Inverter - Engine Instruments
- 22: Fire extinguishing system
- 23: Emergency Jettison CB
- 24: EKSR-46 Flare Launcher, KL-39 Ejection System and SARPP-12GM Flight Data Recorder

PART 3 – COCKPIT & GAUGES

L-39ZA

FRONT COCKPIT

Directional Gyro (GMK-1AE GMC) Mode Selector
GC: Directional Gyro / MC: Magnetic Compass

RT-12 JPT Regulator (EGT Limiter)
Test Switch (I/OFF/II)

Directional Gyro (GMK-1AE GMC) Heading Selector
Clockwise / OFF / Counter-Clockwise

Directional Gyro (GMK-1AE GMC)
Latitude Selector Knob

Directional Gyro (GMK-1AE GMC)
Test switch
0 deg / OFF / 360 deg

Directional Gyro (GMK-1AE GMC) Hemisphere selector
N: North / S: South

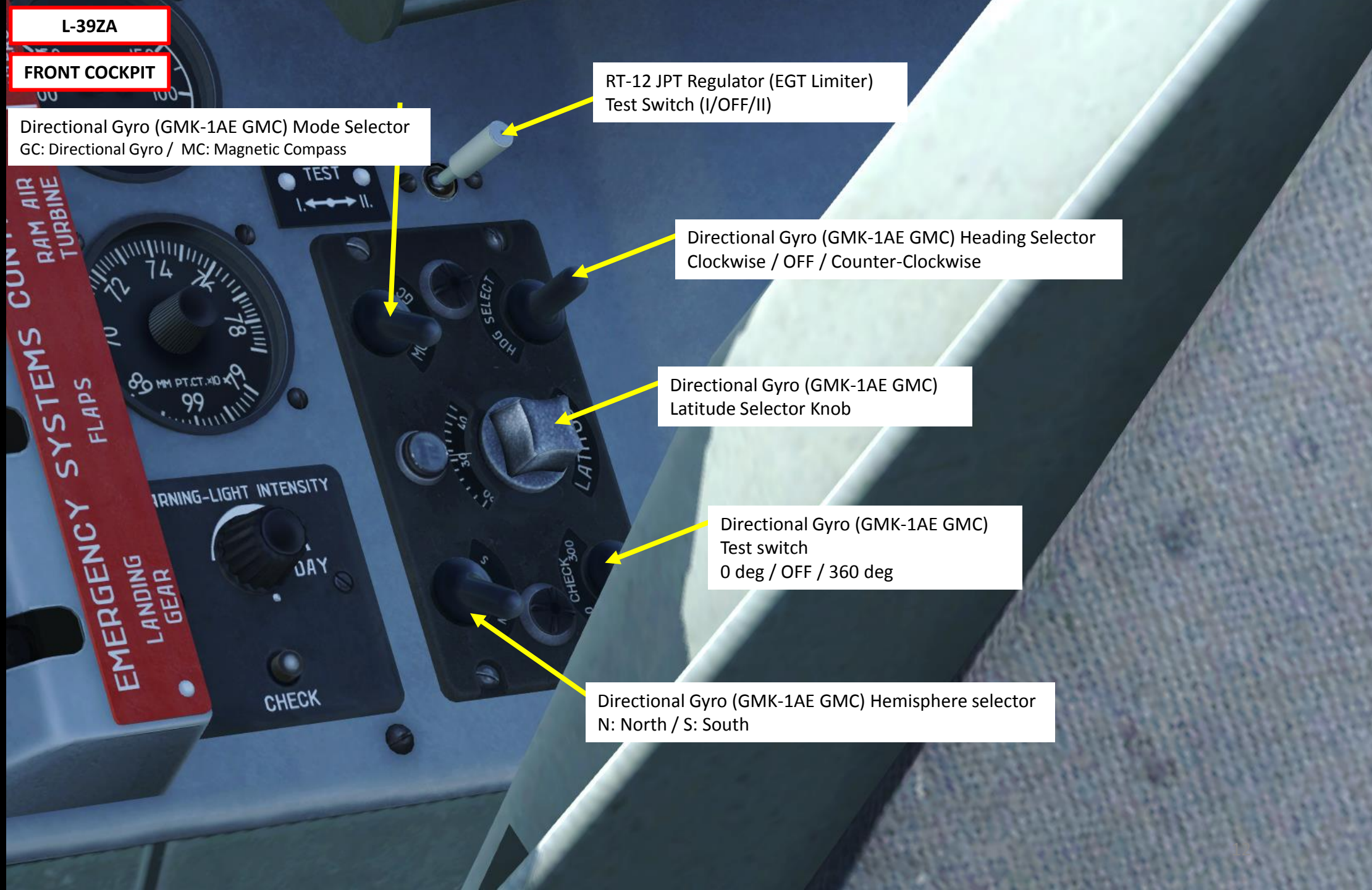

PART 3 – COCKPIT & GAUGES

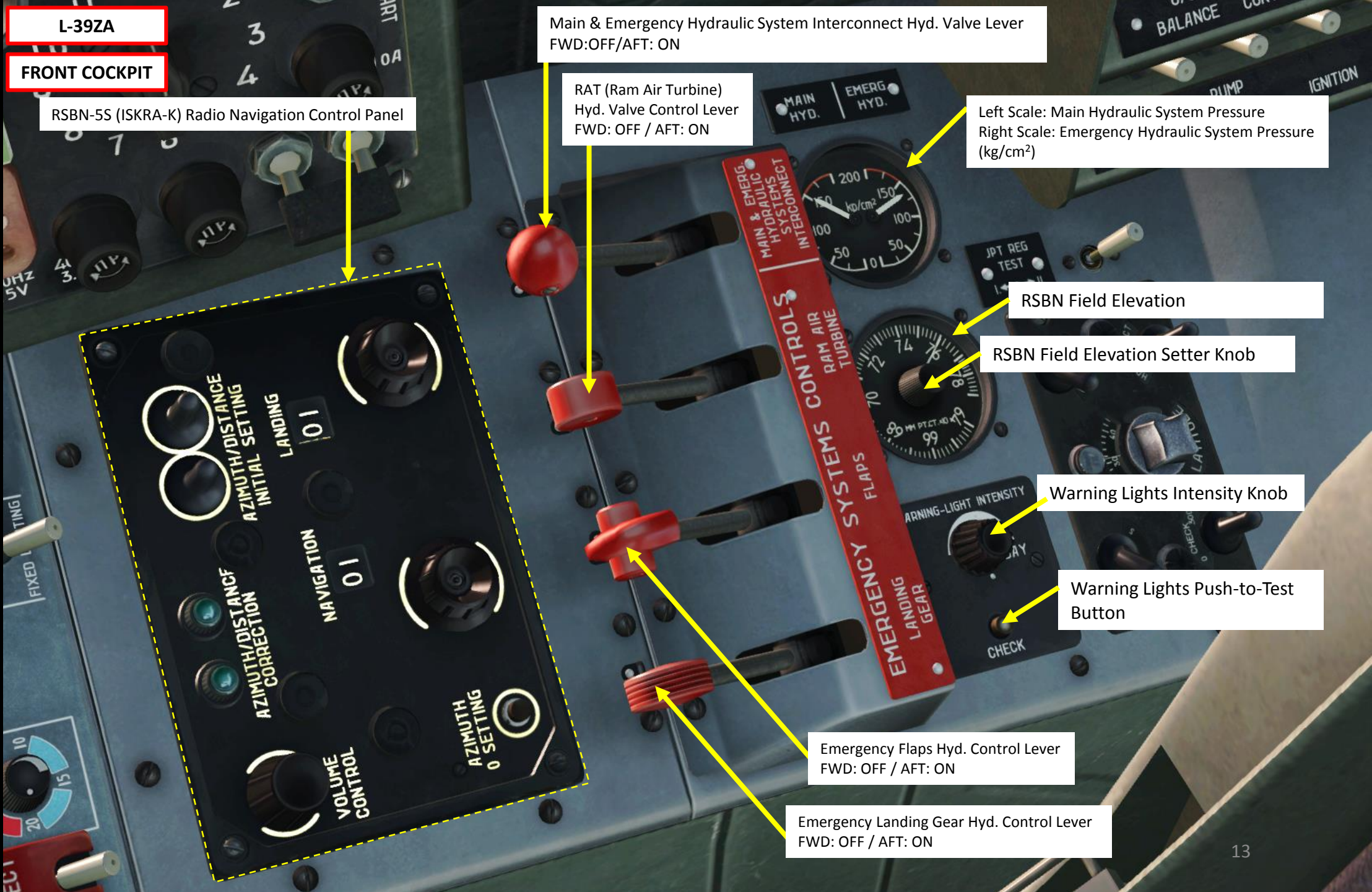

L-39ZA

FRONT COCKPIT

RSBN-5S (ISKRA-K) Radio Navigation Control Panel

Main & Emergency Hydraulic System Interconnect Hyd. Valve Lever
FWD: OFF/AFT: ON

RAT (Ram Air Turbine)
Hyd. Valve Control Lever
FWD: OFF / AFT: ON

Left Scale: Main Hydraulic System Pressure
Right Scale: Emergency Hydraulic System Pressure
(kg/cm²)

RSBN Field Elevation

RSBN Field Elevation Setter Knob

Warning Lights Intensity Knob

Warning Lights Push-to-Test Button

Emergency Flaps Hyd. Control Lever
FWD: OFF / AFT: ON

Emergency Landing Gear Hyd. Control Lever
FWD: OFF / AFT: ON

PART 3 - COCKPIT & GAUGES

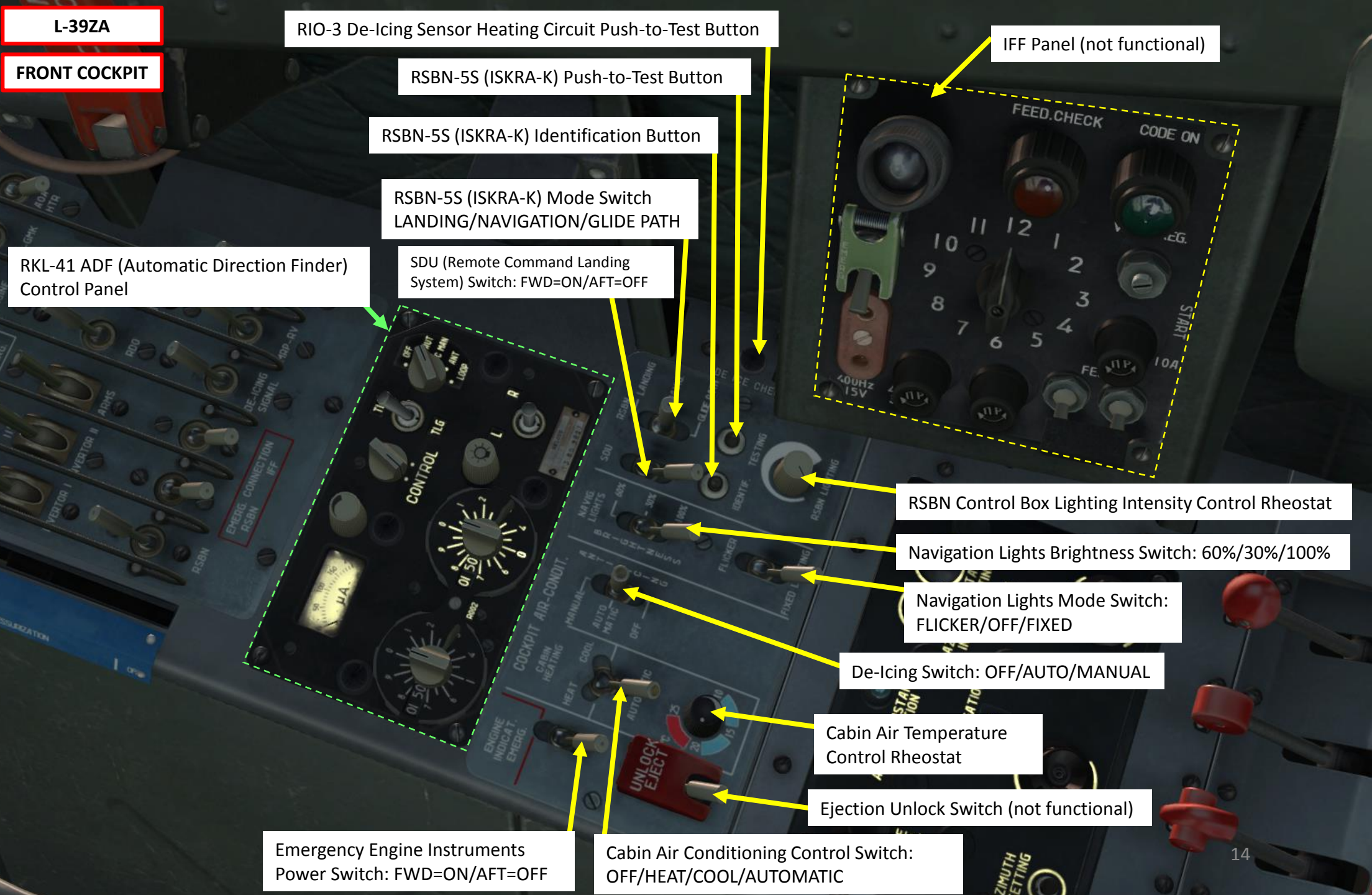

L-39ZA

FRONT COCKPIT

RIO-3 De-Icing Sensor Heating Circuit Push-to-Test Button

RSBN-5S (ISKRA-K) Push-to-Test Button

RSBN-5S (ISKRA-K) Identification Button

RSBN-5S (ISKRA-K) Mode Switch
LANDING/NAVIGATION/GLIDE PATH

RKL-41 ADF (Automatic Direction Finder)
Control Panel

SDU (Remote Command Landing
System) Switch: FWD=ON/AFT=OFF

IFF Panel (not functional)

RSBN Control Box Lighting Intensity Control Rheostat

Navigation Lights Brightness Switch: 60%/30%/100%

Navigation Lights Mode Switch:
FLICKER/OFF/FIXED

De-Icing Switch: OFF/AUTO/MANUAL

Cabin Air Temperature
Control Rheostat

Ejection Unlock Switch (not functional)

Emergency Engine Instruments
Power Switch: FWD=ON/AFT=OFF

Cabin Air Conditioning Control Switch:
OFF/HEAT/COOL/AUTOMATIC

PART 3 – COCKPIT & GAUGES

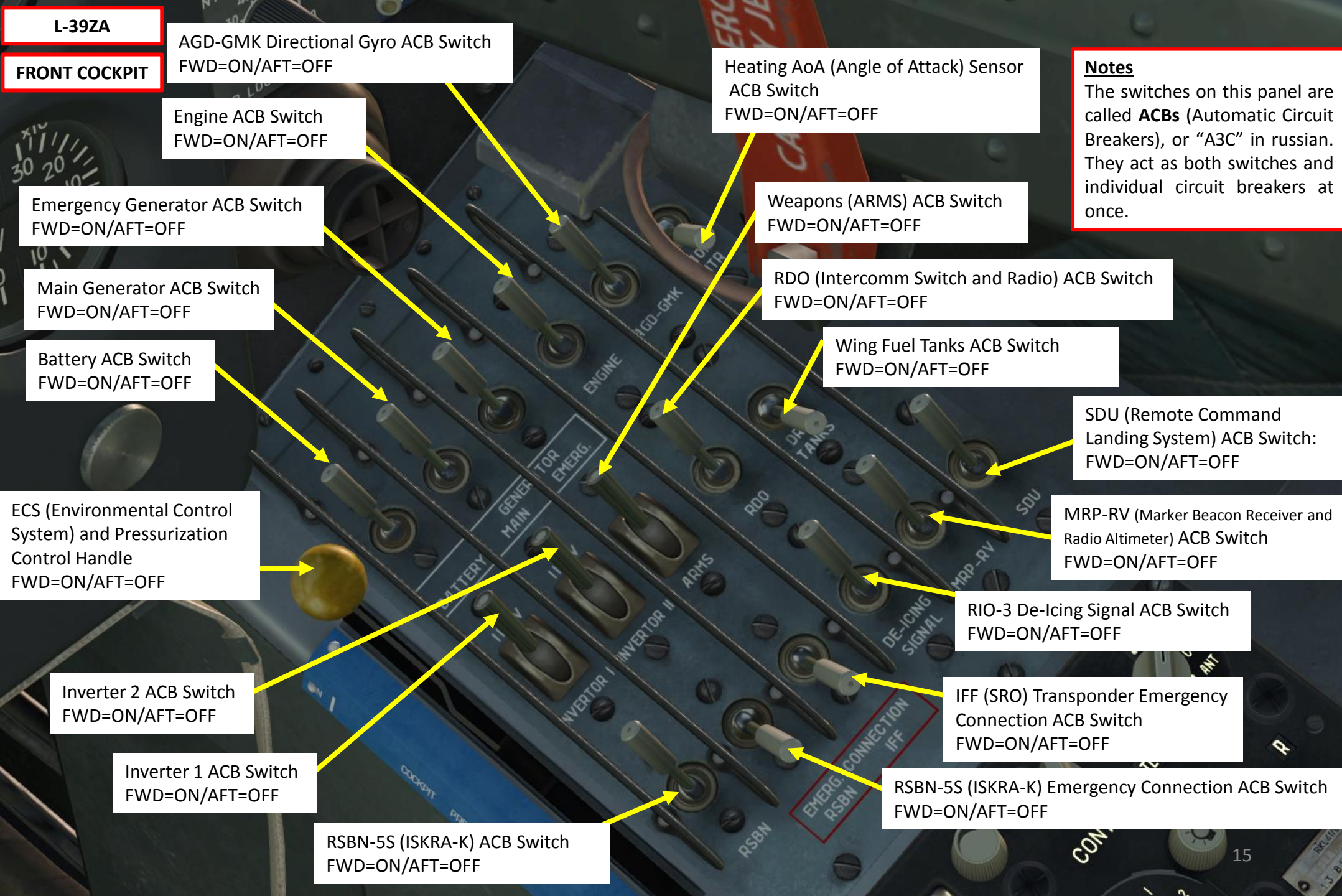

L-39ZA

FRONT COCKPIT

AGD-GMK Directional Gyro ACB Switch
FWD=ON/AFT=OFF

Engine ACB Switch
FWD=ON/AFT=OFF

Emergency Generator ACB Switch
FWD=ON/AFT=OFF

Main Generator ACB Switch
FWD=ON/AFT=OFF

Battery ACB Switch
FWD=ON/AFT=OFF

ECS (Environmental Control System) and Pressurization Control Handle
FWD=ON/AFT=OFF

Inverter 2 ACB Switch
FWD=ON/AFT=OFF

Inverter 1 ACB Switch
FWD=ON/AFT=OFF

RSBN-5S (ISKRA-K) ACB Switch
FWD=ON/AFT=OFF

Heating AoA (Angle of Attack) Sensor ACB Switch
FWD=ON/AFT=OFF

Weapons (ARMS) ACB Switch
FWD=ON/AFT=OFF

RDO (Intercomm Switch and Radio) ACB Switch
FWD=ON/AFT=OFF

Wing Fuel Tanks ACB Switch
FWD=ON/AFT=OFF

Notes
The switches on this panel are called **ACBs** (Automatic Circuit Breakers), or "A3C" in russian. They act as both switches and individual circuit breakers at once.

SDU (Remote Command Landing System) ACB Switch:
FWD=ON/AFT=OFF

MRP-RV (Marker Beacon Receiver and Radio Altimeter) ACB Switch
FWD=ON/AFT=OFF

RIO-3 De-Icing Signal ACB Switch
FWD=ON/AFT=OFF

IFF (SRO) Transponder Emergency Connection ACB Switch
FWD=ON/AFT=OFF

RSBN-5S (ISKRA-K) Emergency Connection ACB Switch
FWD=ON/AFT=OFF

PART 3 – COCKPIT & GAUGES

L-39ZA
FRONT COCKPIT

Vertical velocity Indicator (m/s)

Turn & Slip indicator

Tachometer (Engine %RPM)

EGT (Exhaust Gas Temperature) (x100 deg C)

Fuel Quantity Indicator (x100 kg)

Diffuser and Flight Suit Temperature Rheostat (deg C)

Diffuser and Flight Suit Air Conditioning Control (HEAT/AUTO/COOL)

Ammeter (Amperes)

Voltmeter (Volts)

Engine Vibration Gauge

Canopy Emergency Jettison Handle

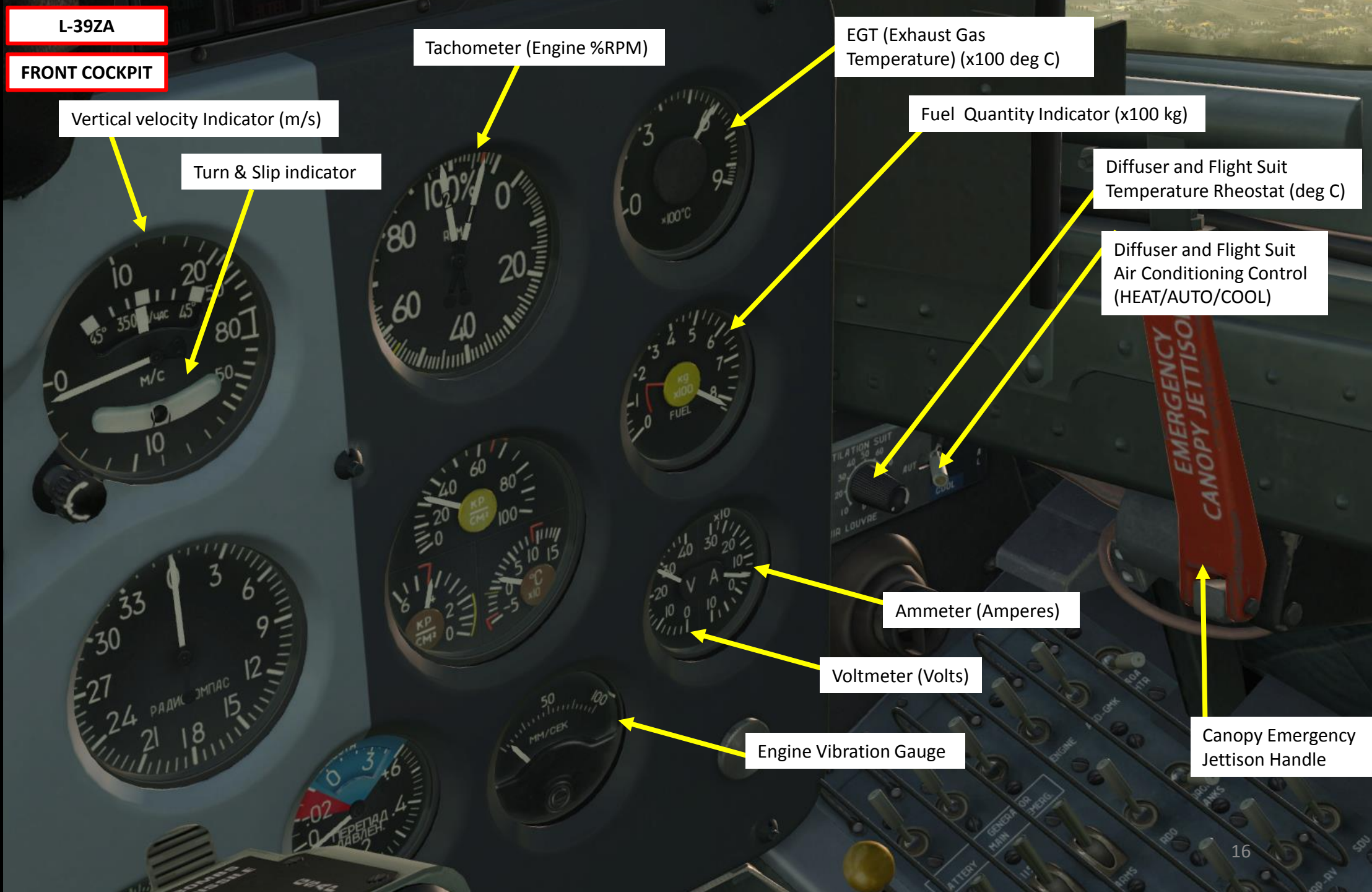

PART 3 – COCKPIT & GAUGES

L-39ZA
FRONT COCKPIT



Attitude Directional Indicator (ADI)

RKL-41 Automatic Direction Finder (ADF) Gauge

Fuel Pressure (kg/cm²)

Oil Temperature (deg C)

Oil Pressure (kg/cm²)

Cockpit Altitude and Pressure Difference Gauge

Clock

RSBN Range Indicator (km)

PART 3 – COCKPIT & GAUGES

L-39ZA

FRONT COCKPIT

Red Index: VNE (Do Not Exceed Airspeed)

Mach Number Scale

Yellow Index: Rotation Speed band for takeoff

Indicated Airspeed (x10 km/h)

True Airspeed (x10 km/h)

Barometric Altimeter Gauge
Outer Scale: Altitude in x100 meters
Inner Scale: Altitude in Kilometers

Radio Magnetic Indicator (RMI)

Barometric pressure (x10 mm Hg)

QFE adjustment knob

Radar Altimeter
Decision Height
Setter Knob

Radar Altimeter Warning Light

Radar Altimeter Gauge (m)

PART 3 – COCKPIT & GAUGES

L-39ZA
FRONT COCKPIT

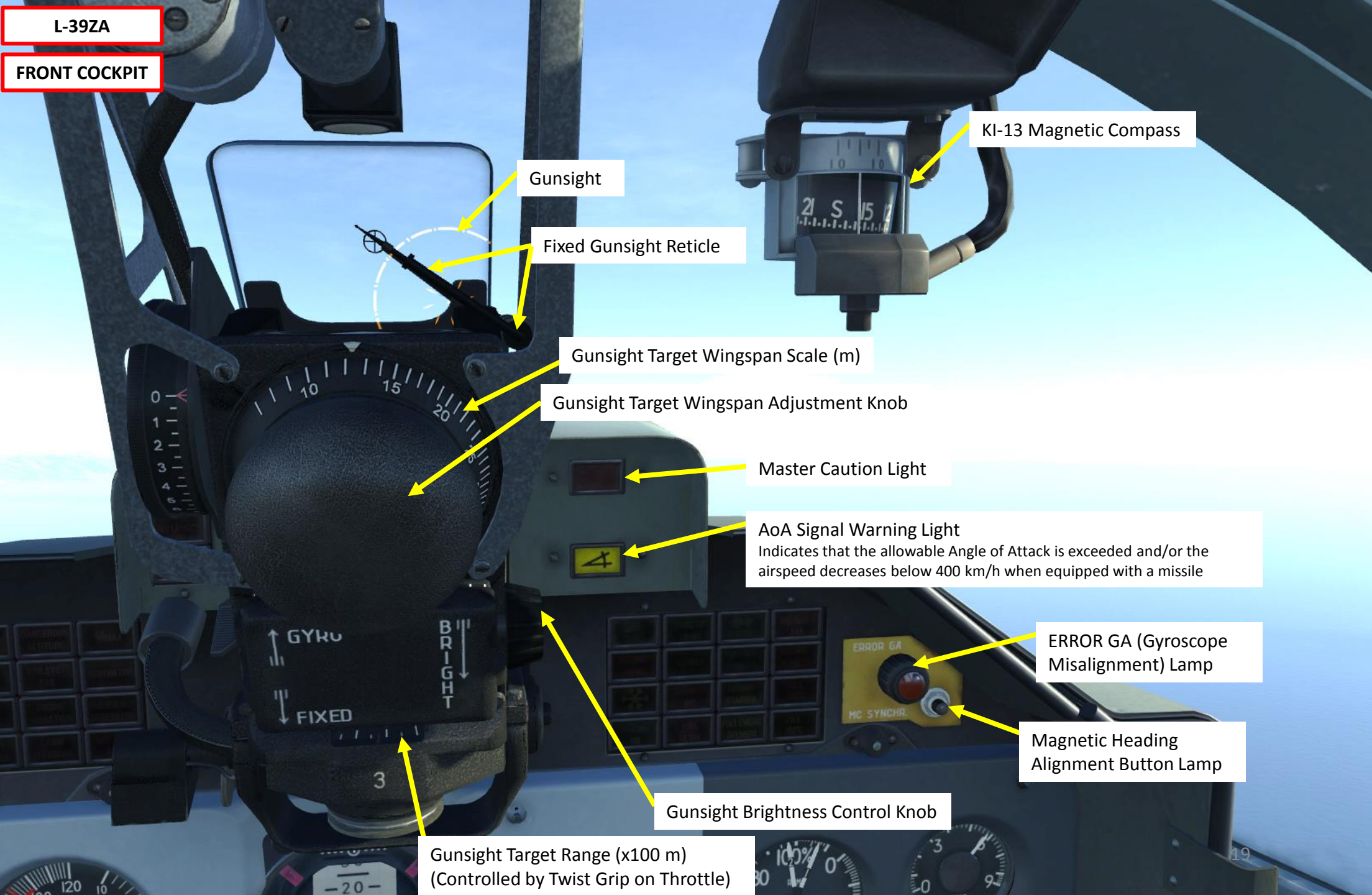

Gunsight

Fixed Gunsight Reticle

KI-13 Magnetic Compass

Gunsight Target Wingspan Scale (m)

Gunsight Target Wingspan Adjustment Knob

Master Caution Light

AoA Signal Warning Light
Indicates that the allowable Angle of Attack is exceeded and/or the airspeed decreases below 400 km/h when equipped with a missile

ERROR GA (Gyroscope Misalignment) Lamp

Magnetic Heading Alignment Button Lamp

Gunsight Brightness Control Knob

Gunsight Target Range (x100 m)
(Controlled by Twist Grip on Throttle)

PART 3 – COCKPIT & GAUGES

L-39ZA

FRONT COCKPIT

STAND ALERT Caution
(Indicates readiness of armament control system, lit when airspeed greater than 310 km/h)

NO LAUNCH Caution
(Illuminated when pulling more than 2 G, which means missiles cannot precisely track target)

EXPLOSIVE Caution
(Indicates that weapons are armed and LIVE)

Emergency Instruments Light Switch
UP=ON / DOWN=OFF

Warning Lights Panel

Gunsight Mirror Depression Angle Control

Gunsight Mode Selector
UP=GYRO / DOWN=FIXED

Caution & Advisory Lights Panel



ACT-HWY-39
Serial 18 881982

↑ GYRO
↓ FIXED

BRIGHT

3



PART 3 – COCKPIT & GAUGES

L-39ZA

Explosive Pyrotechnical Charge Inner Guns
UP = ON / DOWN = OFF

FRONT COCKPIT

Explosive Pyrotechnical Charge Outer Guns
UP = ON / DOWN = OFF

Missile (A/A) and Bomb Release Mode Switch
Portside: LEFT Missile Launch / SINGLE bomb release
Starboard: RIGHT Missile Launch / BOTH bombs release

PK-3 Machine-Gun Pod + GS-23 Cannon
UP = ARMED / DOWN = Not Armed

Bomb Mode Selector
TRAIN / I (Single) / SALVO

Note

Russian gun pods and cannons of this era use a “pyrotechnical” reload system, which means that a cassette equipped with three pyrocartridges will detonate a charge to “reload” a gun. The gun pods installed on the MiG-21 and the cannons installed on the MiG-15bis use a similar system.

Emergency Launch Missile Switch
UP = LAUNCH / DOWN = OFF

Bomb Emergency Jettison Mode Switch
UP = ARMED (LIVE) / DOWN = Not Armed (BLANK)

PYRO III
II
I

Explosive Pyrotechnical Charge Switch
I / II / III: Selects Explosive Charge # I, II or III

EXPL. CHARGE GUNS OUTER
EXPL. CHARGE GUNS INNER
EXPL. CHARGE GS

Explosive Pyrotechnical Charge GS-23 Cannon Switch

PK3 + GS
A-A
MISS. TRAIN.

Rocket Firing Mode Selector Switch
MISS. TRAIN (Automatic) / 2 / 4

BOMBS TRAIN. STARB. WEAPON CARRIER

Upper Button (White): Select Inboard Pylons
Lower Button (Red): Deselect Inboard Pylons

SALVO

Upper Button (White): Select Outboard Pylons
Lower Button (Red): Deselect Outboard Pylons

EMERGENCY

Emergency Jettison Switch – Inner Pylons
UP = JETTISON / DOWN = OFF

AA MISSILE
LIVE
EMERGENCY

Emergency Jettison Switch – Outer Pylons
UP = JETTISON / DOWN = OFF

PART 3 – COCKPIT & GAUGES

L-39ZA

FRONT COCKPIT

Canopy Lock Handle
FWD: LOCKED / AFT: UNLOCKED

Landing Gear Extend Caution Light
EXTEND U/C = Flaps are deployed in landing position but landing gear is not deployed

Landing Gear Door Status Indicator
U/C DOORS OUT= DOORS OPEN

Airbrake Status Indicator
AIR BRAKE OUT = DEPLOYED

Landing Gear Status Indicator
RED = RETRACTED
GREEN = DEPLOYED

Landing Gear Control Lever
UP = Retracted
DOWN = Deployed

Accelerometer (g)

RKL-41 ADF Outer-Inner Beacon Selector (Far-Near NDB switch)
O: Outer (Far) / I: Inner (Near)

PART 3 – COCKPIT & GAUGES

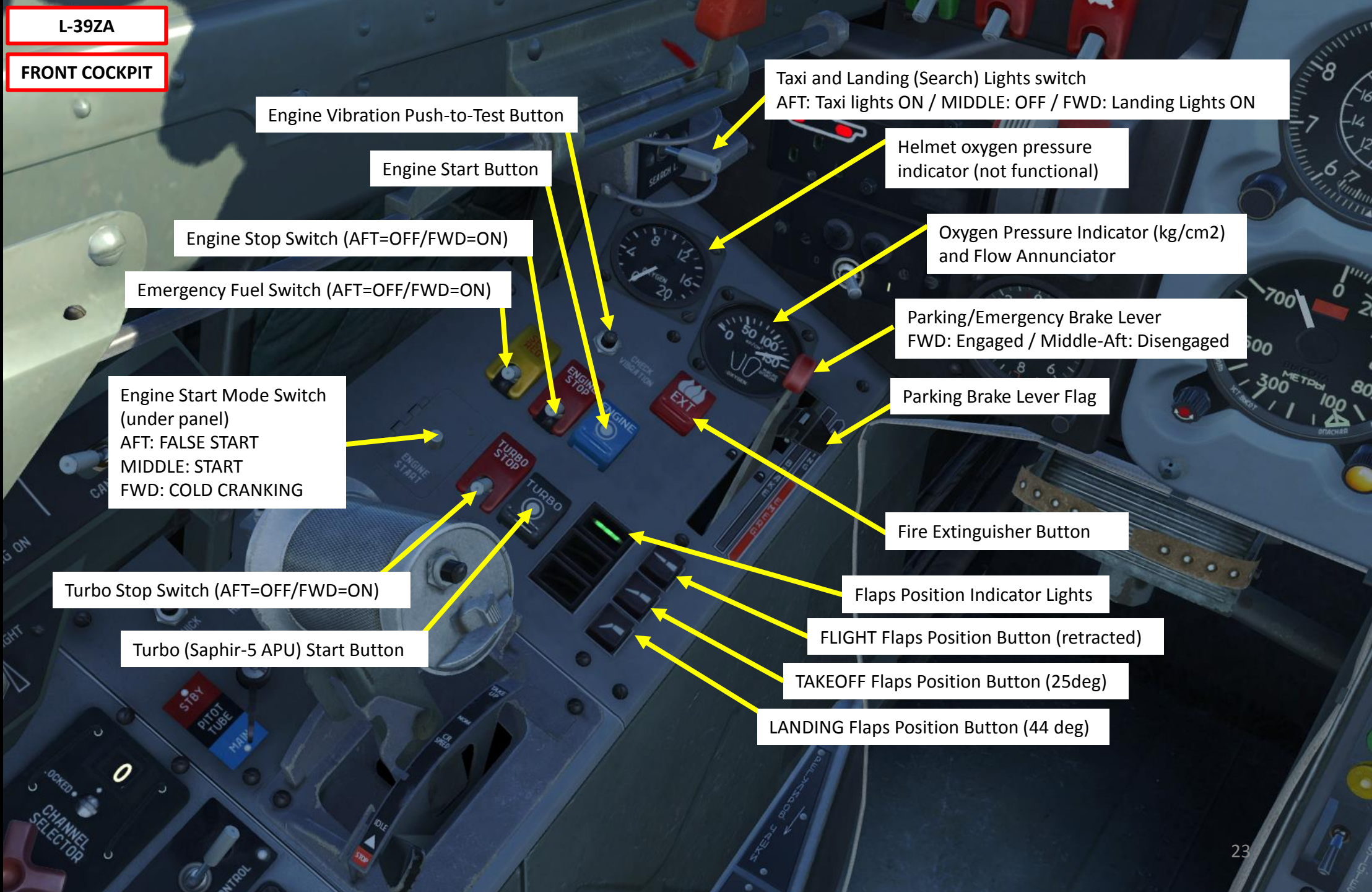

L-39ZA

FRONT COCKPIT

Engine Vibration Push-to-Test Button

Engine Start Button

Engine Stop Switch (AFT=OFF/FWD=ON)

Emergency Fuel Switch (AFT=OFF/FWD=ON)

Engine Start Mode Switch
(under panel)
AFT: FALSE START
MIDDLE: START
FWD: COLD CRANKING

Turbo Stop Switch (AFT=OFF/FWD=ON)

Turbo (Saphir-5 APU) Start Button

Taxi and Landing (Search) Lights switch
AFT: Taxi lights ON / MIDDLE: OFF / FWD: Landing Lights ON

Helmet oxygen pressure indicator (not functional)

Oxygen Pressure Indicator (kg/cm²) and Flow Annunciator

Parking/Emergency Brake Lever
FWD: Engaged / Middle-Aft: Disengaged

Parking Brake Lever Flag

Fire Extinguisher Button

Flaps Position Indicator Lights

FLIGHT Flaps Position Button (retracted)

TAKEOFF Flaps Position Button (25deg)

LANDING Flaps Position Button (44 deg)

PART 3 – COCKPIT & GAUGES

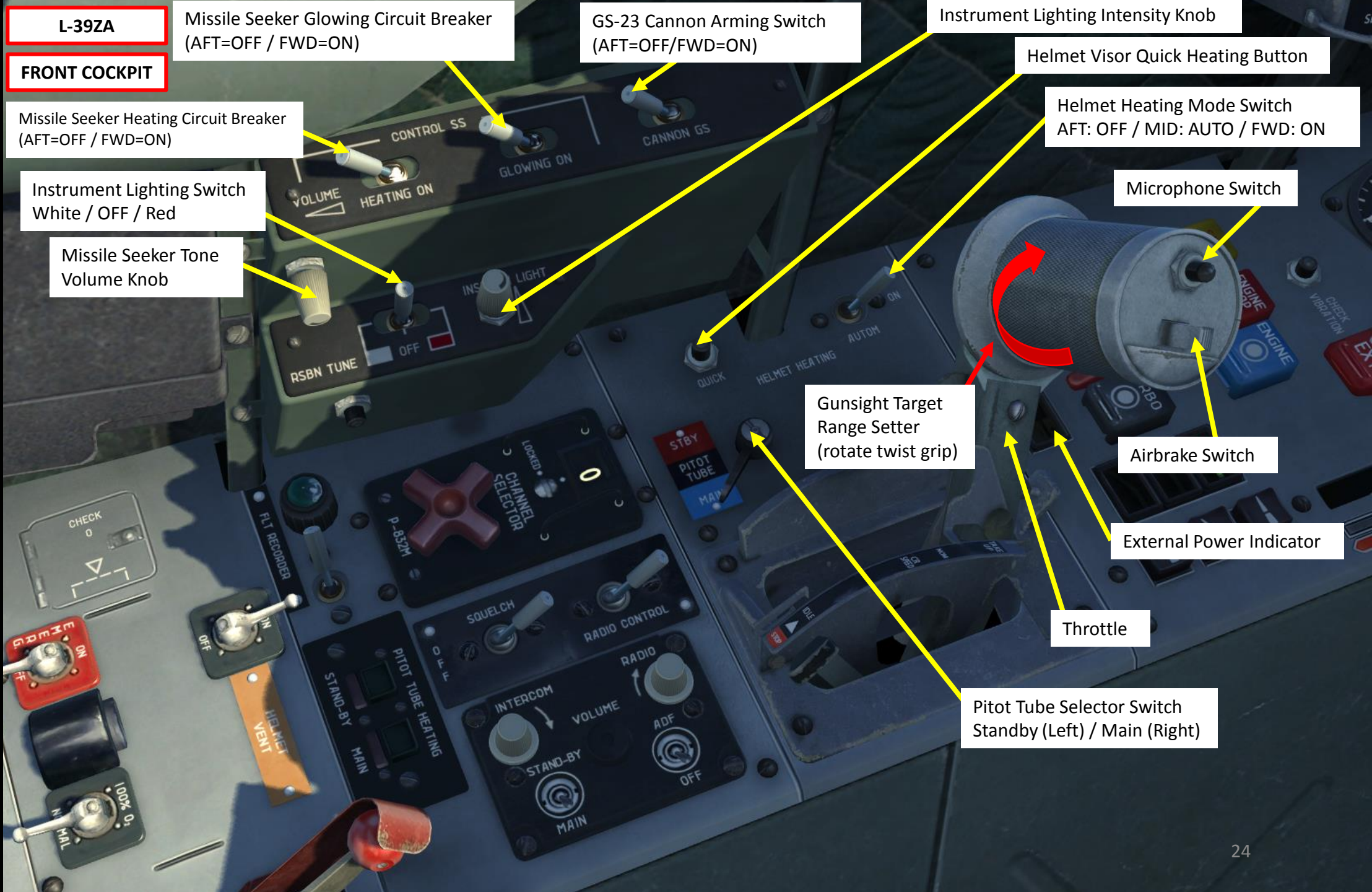

L-39ZA

Missile Seeker Glowing Circuit Breaker (AFT=OFF / FWD=ON)

GS-23 Cannon Arming Switch (AFT=OFF/FWD=ON)

Instrument Lighting Intensity Knob

FRONT COCKPIT

Helmet Visor Quick Heating Button

Missile Seeker Heating Circuit Breaker (AFT=OFF / FWD=ON)

Helmet Heating Mode Switch
AFT: OFF / MID: AUTO / FWD: ON

Instrument Lighting Switch
White / OFF / Red

Microphone Switch

Missile Seeker Tone
Volume Knob

Gunsight Target
Range Setter
(rotate twist grip)

Airbrake Switch

External Power Indicator

Throttle

Pitot Tube Selector Switch
Standby (Left) / Main (Right)

PART 3 – COCKPIT & GAUGES

L-39ZA

FRONT COCKPIT

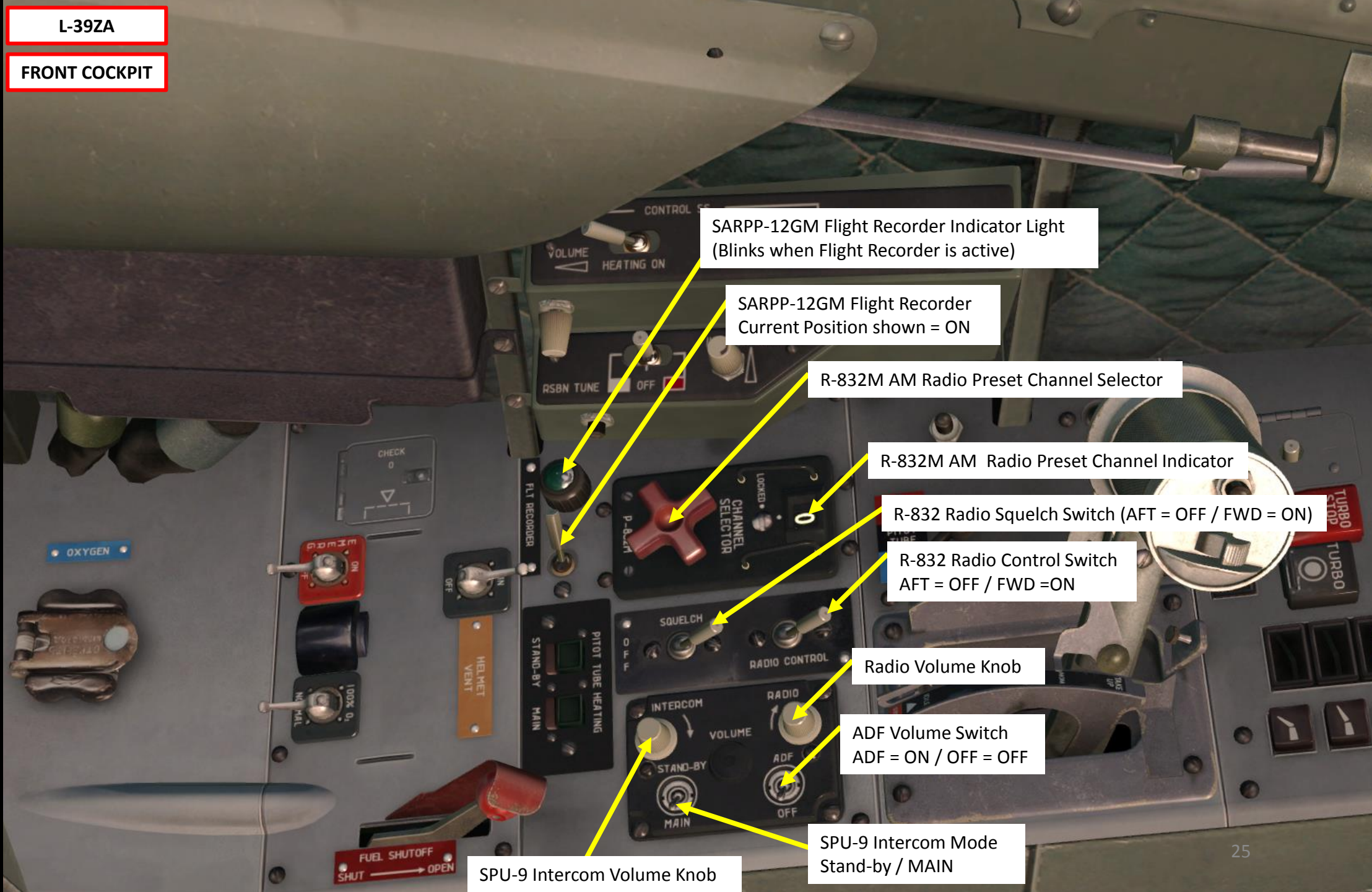

SARPP-12GM Flight Recorder Indicator Light
(Blinks when Flight Recorder is active)

SARPP-12GM Flight Recorder
Current Position shown = ON

R-832M AM Radio Preset Channel Selector

R-832M AM Radio Preset Channel Indicator

R-832 Radio Squelch Switch (AFT = OFF / FWD = ON)

R-832 Radio Control Switch
AFT = OFF / FWD = ON

Radio Volume Knob

ADF Volume Switch
ADF = ON / OFF = OFF

SPU-9 Intercom Mode
Stand-by / MAIN

SPU-9 Intercom Volume Knob

PART 3 - COCKPIT & GAUGES

L-39ZA

FRONT COCKPIT

Oxygen Supply Valve
CLOSE VALVE = Turn Clockwise
OPEN VALVE = Turn Counter-Clockwise

Emergency Oxygen Switch
AFT = OFF / FWD = ON

Diluter Demand Switch
AFT = Normal Mix / FWD = 100%

Fuel Shutoff Lever
AFT = FUEL VALVE SHUT (NO FUEL AVAIL.)
FWD = FUEL VALVE OPEN (FUEL AVAIL.)

Helmet Ventilation Switch
AFT = OFF / FWD = ON

Standby (Left) Pitot Tube Heating OFF Button
PUSHED = OFF

Standby (Left) Pitot Tube Heating ON Button
PUSHED = ON

Main (Right) Pitot Tube Heating ON Button
PUSHED = ON

Main (Right) Pitot Tube Heating OFF Button
PUSHED = OFF

PART 3 – COCKPIT & GAUGES

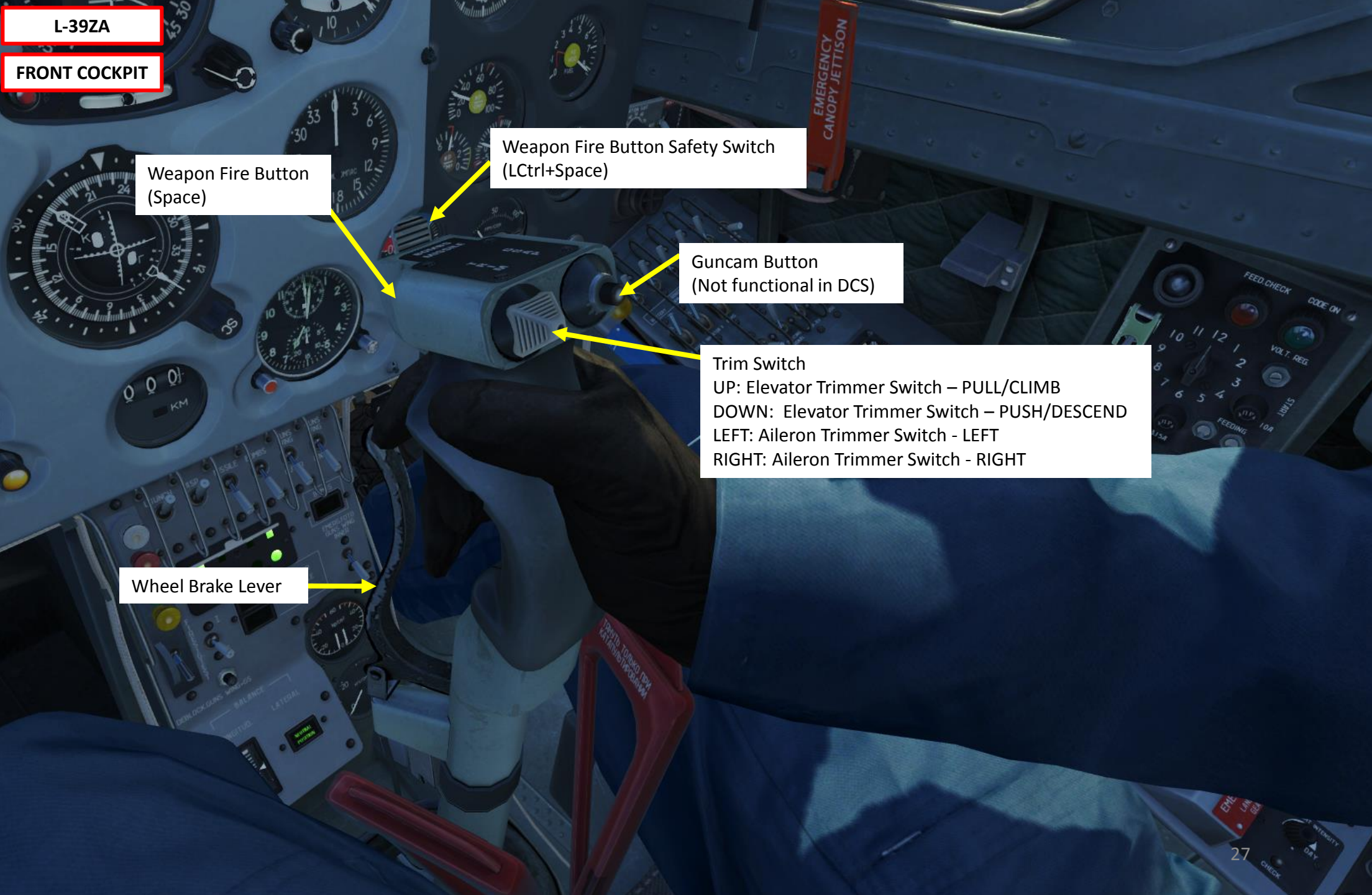

L-39ZA

FRONT COCKPIT

Weapon Fire Button
(Space)

Weapon Fire Button Safety Switch
(L Ctrl + Space)

Guncam Button
(Not functional in DCS)

Trim Switch
UP: Elevator Trimmer Switch – PULL/CLIMB
DOWN: Elevator Trimmer Switch – PUSH/DESCEND
LEFT: Aileron Trimmer Switch - LEFT
RIGHT: Aileron Trimmer Switch - RIGHT

Wheel Brake Lever

PART 3 – COCKPIT & GAUGES

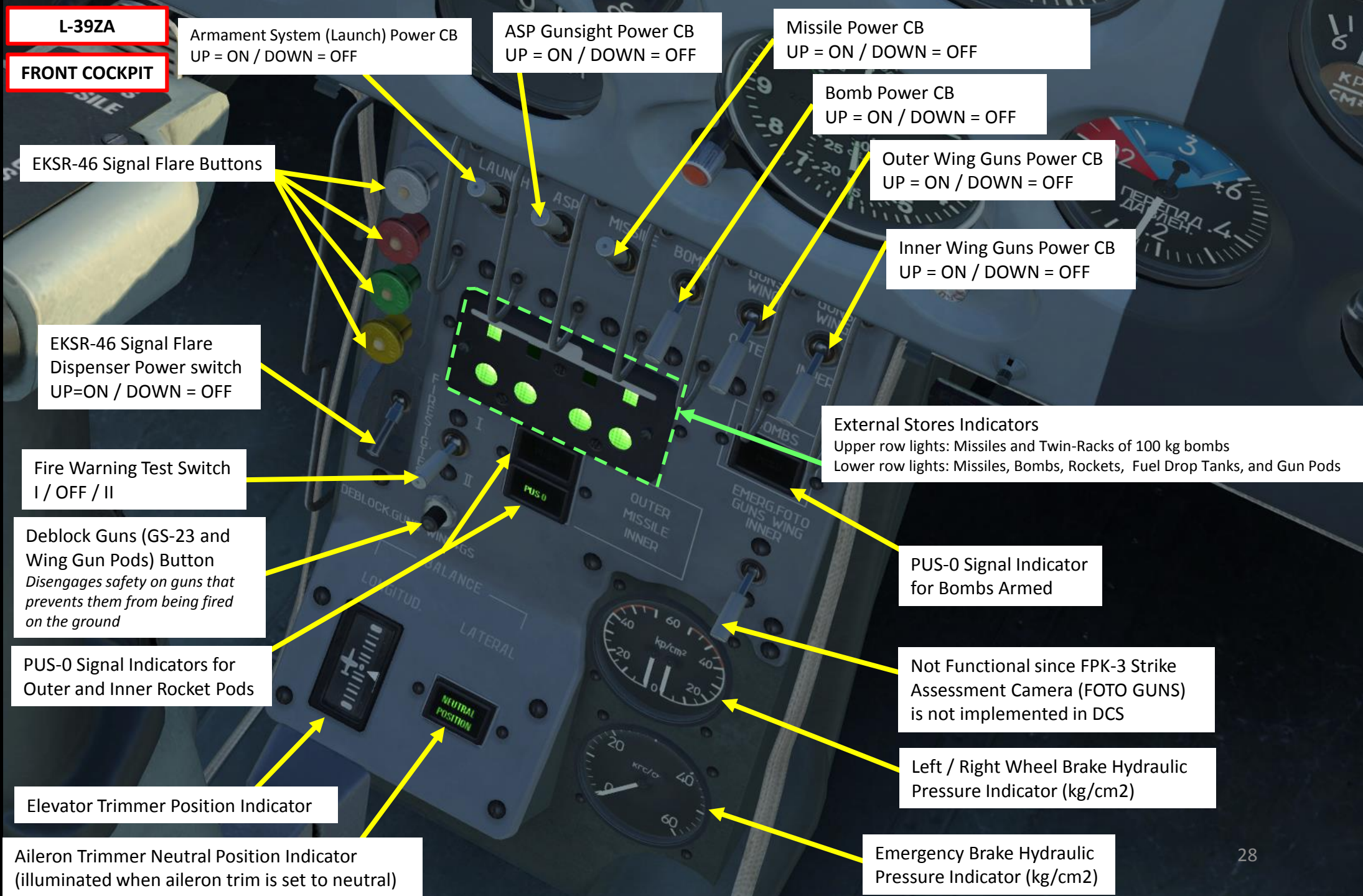

PART 3 – COCKPIT & GAUGES

L-39ZA

REAR COCKPIT



PART 3 – COCKPIT & GAUGES

L-39ZA

REAR COCKPIT

Instrument Flight Practice Hood

Instrument Flight Practice Hood
Control Lever
AFT: RETRACTED / FWD: EXTENDED

PART 3 – COCKPIT & GAUGES

L-39ZA

Instrument Flight Practice Hood



PART 3 – COCKPIT & GAUGES

L-39ZA
REAR COCKPIT



Warning Lights Panel

Master Caution Light

Caution & Advisory Lights Panel

External Stores Indicators

Upper row lights: Missiles and Twin-Racks of 100 kg bombs
Lower row lights: Missiles, Bombs, Rockets, Fuel Drop Tanks, and Gun Pods

STAND ALERT / NO LAUNCH /EXPLOSION
Warning Lights

ARMAMENT FIRE / GLOWING ON / ROCKETS HEATING
Advisory Lights

PART 3 – COCKPIT & GAUGES

L-39ZA

REAR COCKPIT

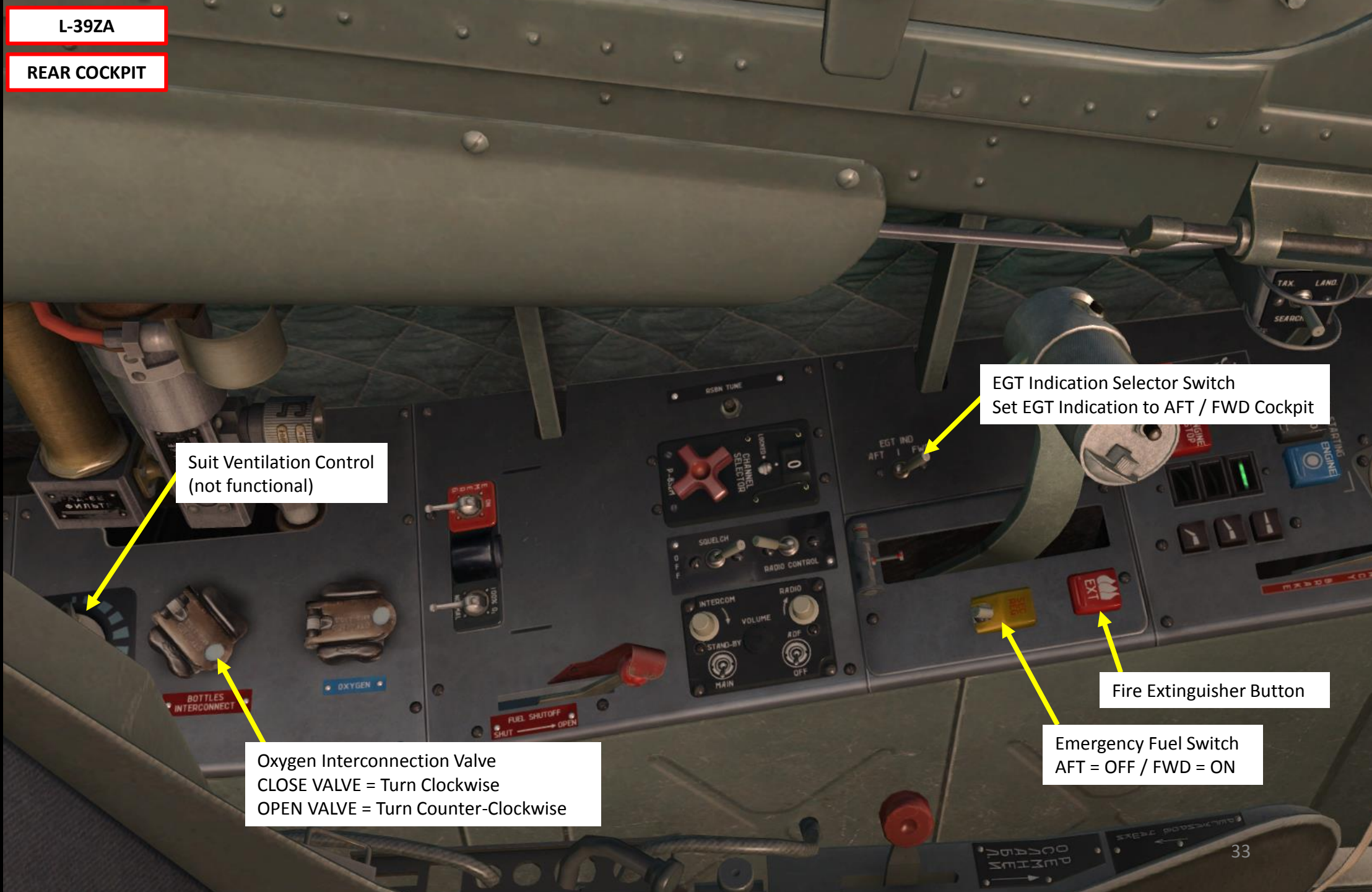

Suit Ventilation Control
(not functional)

BOTTLES
INTERCONNECT

Oxygen Interconnection Valve
CLOSE VALVE = Turn Clockwise
OPEN VALVE = Turn Counter-Clockwise

FUEL SHUTOFF
SHUT → OPEN

CHANNEL
SELECTOR
SQUELCH
RADIO CONTROL
INTERCOM
RADIO
VOLUME
STAND-BY
MAIN
RDF
OFF

EGT Indication Selector Switch
Set EGT Indication to AFT / FWD Cockpit

EGT IND
AFT | FWD

Fire Extinguisher Button

EXT

Emergency Fuel Switch
AFT = OFF / FWD = ON

EMERGENCY
FUEL

PART 3 – COCKPIT & GAUGES

L-39ZA

REAR COCKPIT

Failure Simulation Control Panel

Total Pressure Pitot Failure Simulation Switch
ON = Pitot Functional
FAILURE = Pitot Failure Simulated

Note
Pressure guards are installed on the front cockpit's pressure gauges to avoid damage to these gauges when switching from FAILURE to the ON position. To enable pressure gauges in the front cockpit after a pressure failure simulation, the Instructor Pilot must:

- 1) Ensure the appropriate Pitot Failure selector switch is set to FAILURE
- 2) Set selector switch to RED MIN 30"
- 3) Wait for 30 seconds
- 4) Set selector switch to ON

Aileron Trim "Neutral" Position Indicator

Elevator Trim "Neutral" Position Indicator

GMK Directional Gyro Failure Simulation Switch
UP = Failure Simulated

Attitude Directional Indicator (ADI) Pitch Axis Failure Simulation Switch
UP = Failure Simulated

Static Pressure Pitot Failure Simulation Switch
ON = Pitot Functional
FAILURE = Pitot Failure Simulated

RKL-41 ADF (Automatic Direction Finder) Failure Simulation Switch
UP = Failure Simulated

Attitude Directional Indicator (ADI) Roll Axis Failure Simulation Switch
UP = Failure Simulated

Left / Right Wheel Brake Hydraulic Pressure Indicator (kg/cm²)

PART 3 – COCKPIT & GAUGES

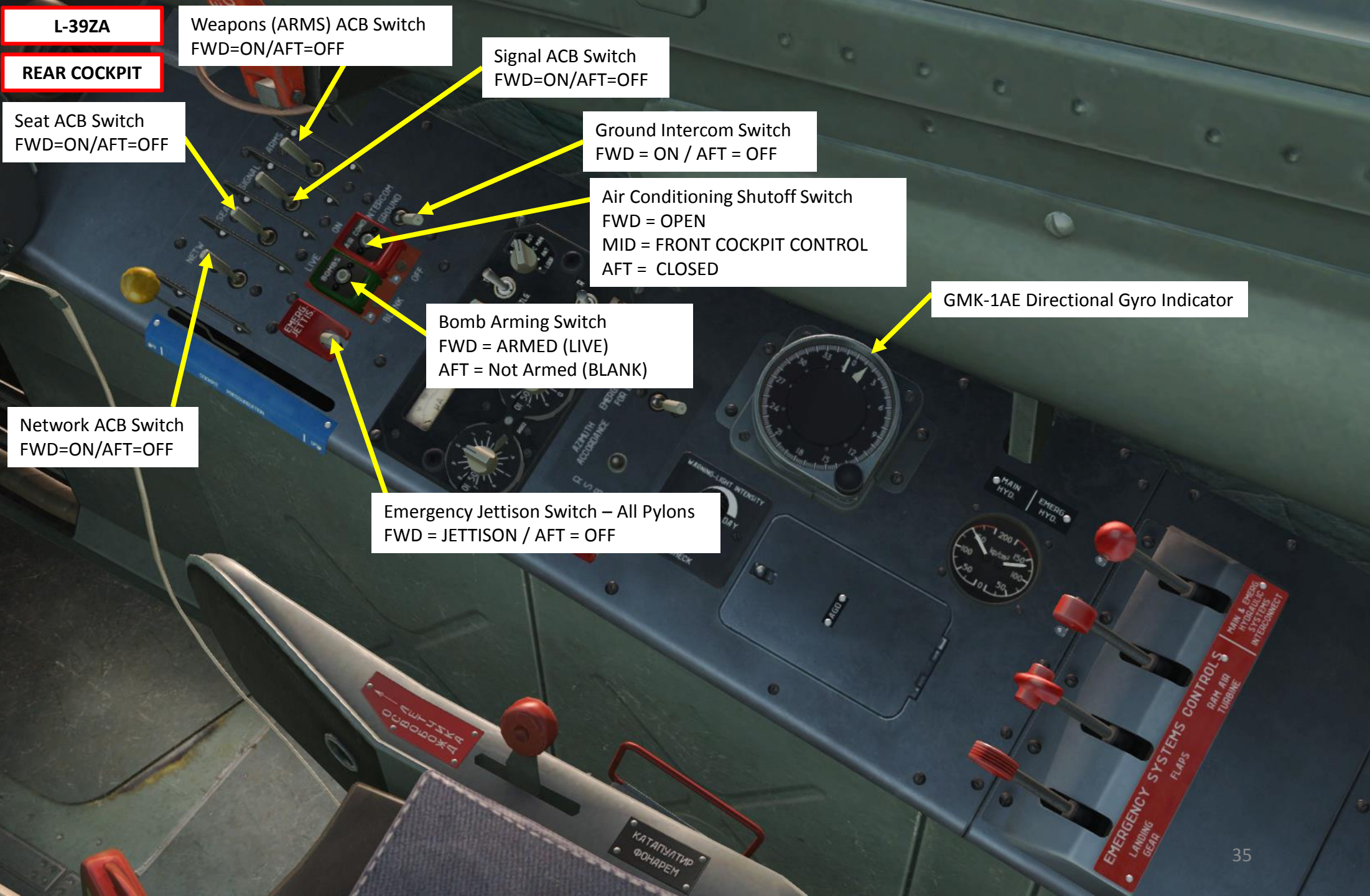

L-39ZA

REAR COCKPIT

Weapons (ARMS) ACB Switch
FWD=ON/AFT=OFF

Signal ACB Switch
FWD=ON/AFT=OFF

Seat ACB Switch
FWD=ON/AFT=OFF

Ground Intercom Switch
FWD = ON / AFT = OFF

Air Conditioning Shutoff Switch
FWD = OPEN
MID = FRONT COCKPIT CONTROL
AFT = CLOSED

GMK-1AE Directional Gyro Indicator

Bomb Arming Switch
FWD = ARMED (LIVE)
AFT = Not Armed (BLANK)

Network ACB Switch
FWD=ON/AFT=OFF

Emergency Jettison Switch – All Pylons
FWD = JETTISON / AFT = OFF

EMERGENCY SYSTEMS CONTROLS
LANDING GEAR
FLAPS
RAM AIR TURBINE
MAIN & EMERG HYDRAULIC SYSTEMS INTERCONNECT

PART 3 – COCKPIT & GAUGES

L-39ZA



RAT: Ram Air Turbine

Automatically deployed in case of engine failure in order to supply hydraulic power to hydraulic systems, which powers flight controls.

PART 3 – COCKPIT & GAUGES

L-39C

FRONT COCKPIT

AGD-GMK Directional Gyro ACB Switch
FWD=ON/AFT=OFF

Engine ACB Switch
FWD=ON/AFT=OFF

Emergency Generator ACB Switch
FWD=ON/AFT=OFF

Main Generator ACB Switch
FWD=ON/AFT=OFF

Battery ACB Switch
FWD=ON/AFT=OFF

ECS (Environmental Control System) and Pressurization Control Handle
FWD=ON/AFT=OFF

Inverter 1 ACB Switch
FWD=ON/AFT=OFF

Inverter 2 ACB Switch
FWD=ON/AFT=OFF

RDO (Intercomm Switch and Radio) ACB Switch
FWD=ON/AFT=OFF

RSBN-5S (ISKRA-K) ACB Switch
FWD=ON/AFT=OFF

MRP-RV (Marker Beacon Receiver and Radio Altimeter) ACB Switch
FWD=ON/AFT=OFF

SDU (Remote Command Landing System) ACB Switch:
FWD=ON/AFT=OFF

RIO-3 De-Icing Signal ACB Switch
FWD=ON/AFT=OFF

Wing Fuel Tanks ACB Switch
FWD=ON/AFT=OFF

RSBN-5S (ISKRA-K) Emergency Connection ACB Switch
FWD=ON/AFT=OFF

IFF (SRO) Transponder Emergency Connection ACB Switch
FWD=ON/AFT=OFF

Notes

The switches on this panel are called **ACBs** (Automatic Circuit Breakers), or "A3C" in Russian. They act as both switches and individual circuit breakers at once.

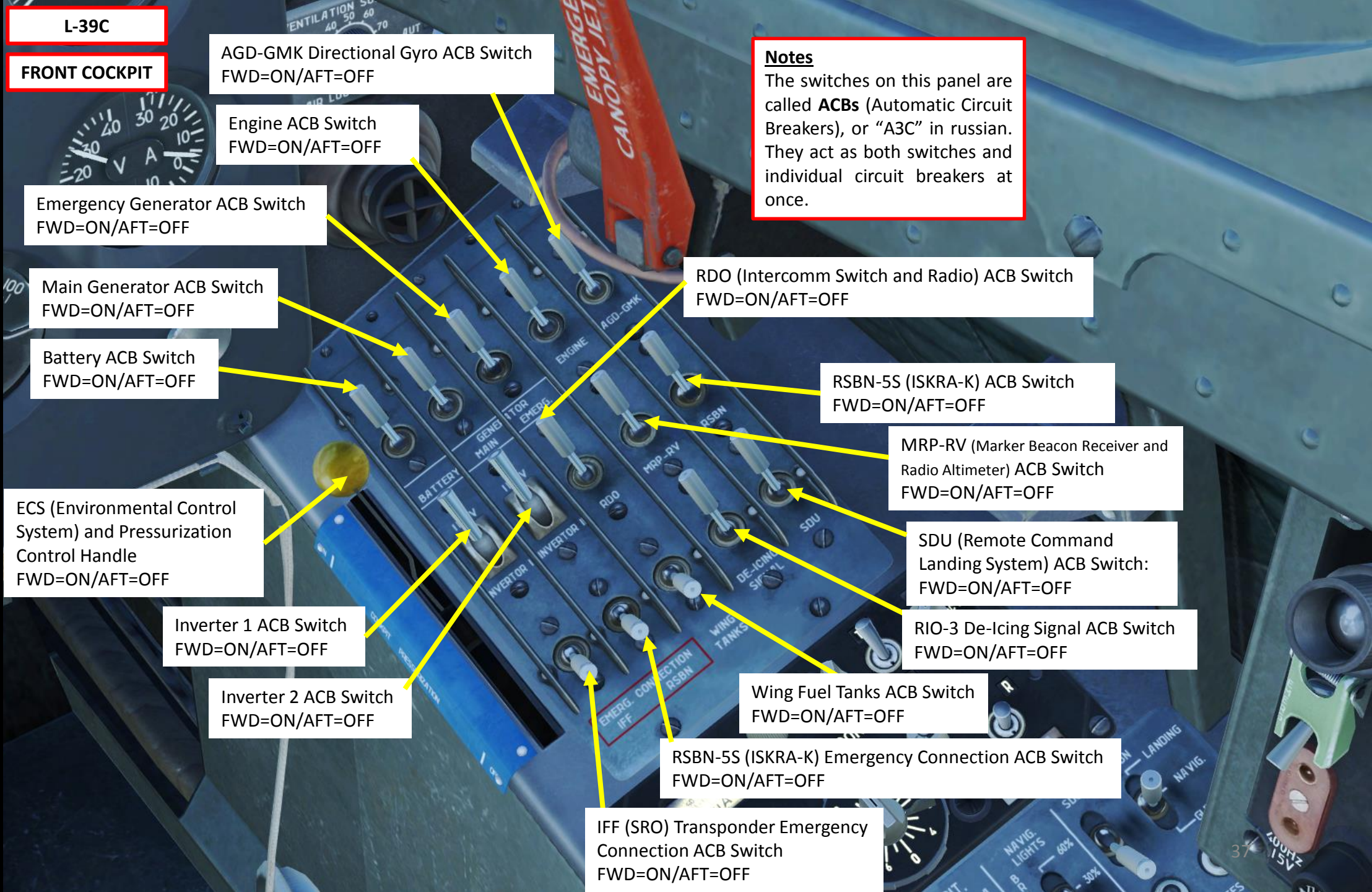

PART 3 – COCKPIT & GAUGES

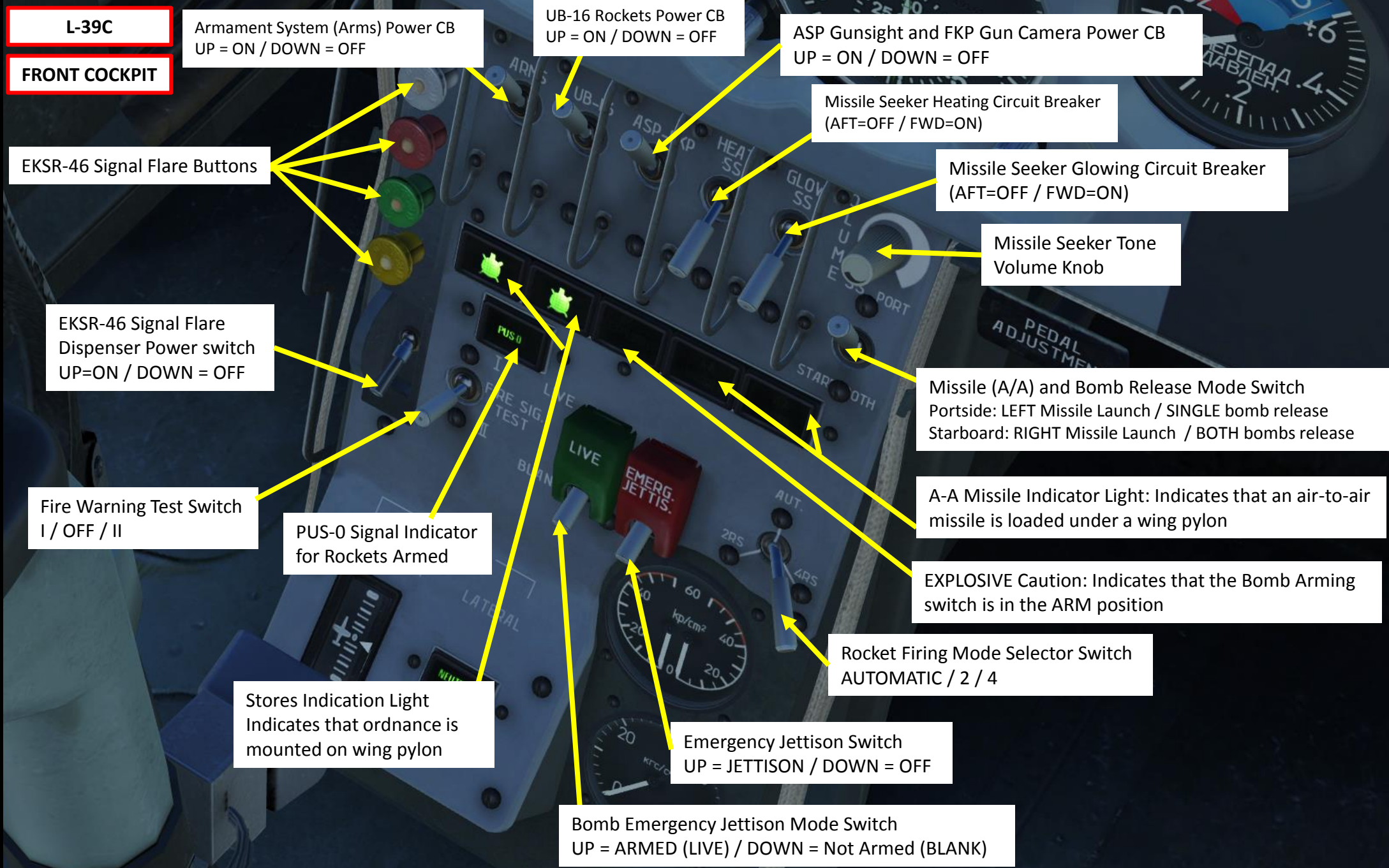

L-39C

FRONT COCKPIT

Armament System (Arms) Power CB
UP = ON / DOWN = OFF

UB-16 Rockets Power CB
UP = ON / DOWN = OFF

ASP Gunsight and FKP Gun Camera Power CB
UP = ON / DOWN = OFF

Missile Seeker Heating Circuit Breaker
(AFT=OFF / FWD=ON)

Missile Seeker Glowing Circuit Breaker
(AFT=OFF / FWD=ON)

Missile Seeker Tone
Volume Knob

EKS-46 Signal Flare Buttons

EKS-46 Signal Flare
Dispenser Power switch
UP=ON / DOWN = OFF

Fire Warning Test Switch
I / OFF / II

PUS-0 Signal Indicator
for Rockets Armed

Stores Indication Light
Indicates that ordnance is
mounted on wing pylon

Bomb Emergency Jettison Mode Switch
UP = ARMED (LIVE) / DOWN = Not Armed (BLANK)

Emergency Jettison Switch
UP = JETTISON / DOWN = OFF

Rocket Firing Mode Selector Switch
AUTOMATIC / 2 / 4

EXPLOSIVE Caution: Indicates that the Bomb Arming
switch is in the ARM position

A-A Missile Indicator Light: Indicates that an air-to-air
missile is loaded under a wing pylon

Missile (A/A) and Bomb Release Mode Switch
Portside: LEFT Missile Launch / SINGLE bomb release
Starboard: RIGHT Missile Launch / BOTH bombs release

PART 3 – COCKPIT & GAUGES

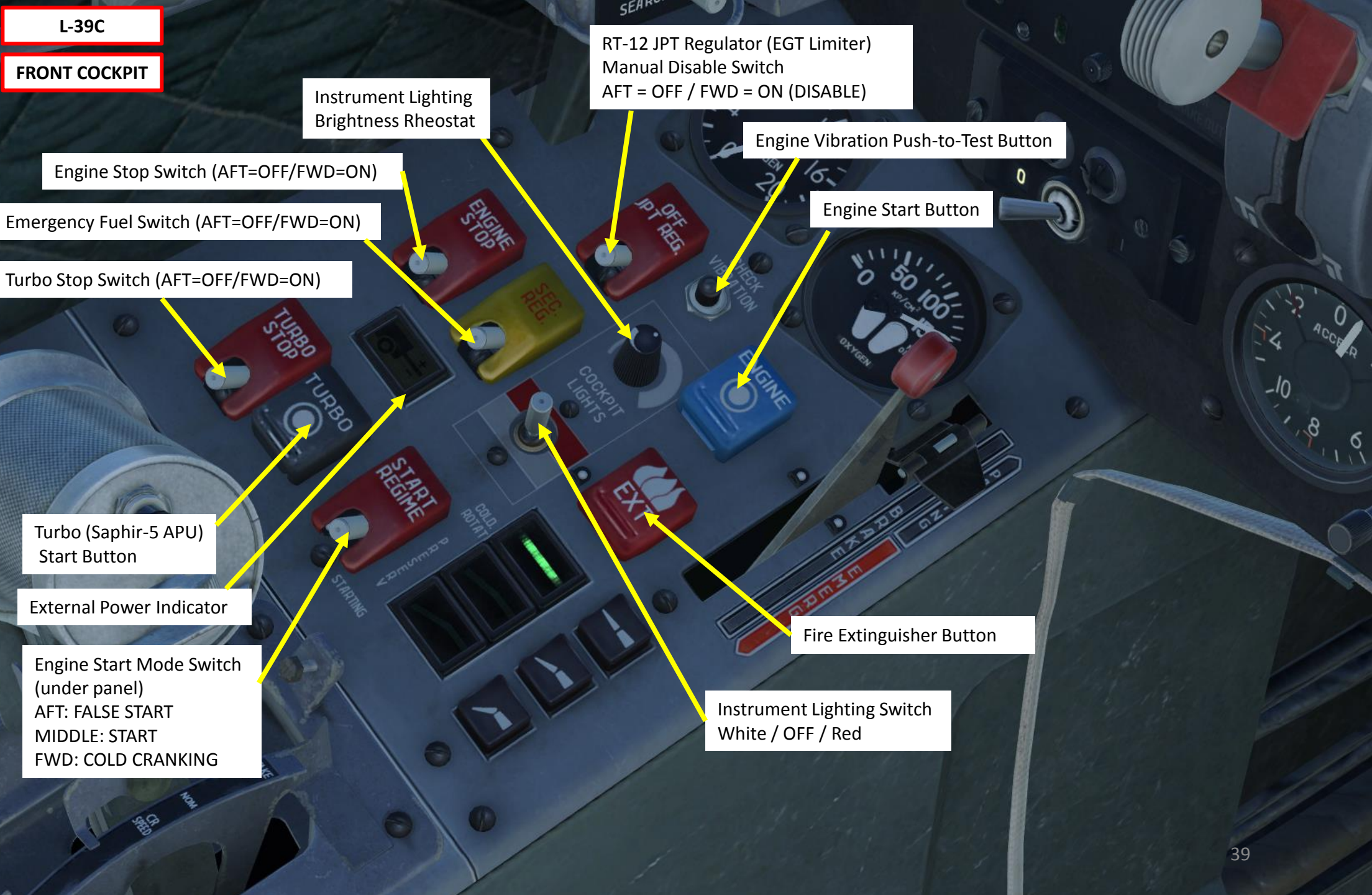

L-39C

FRONT COCKPIT

Instrument Lighting
Brightness Rheostat

RT-12 JPT Regulator (EGT Limiter)
Manual Disable Switch
AFT = OFF / FWD = ON (DISABLE)

Engine Stop Switch (AFT=OFF/FWD=ON)

Engine Vibration Push-to-Test Button

Emergency Fuel Switch (AFT=OFF/FWD=ON)

Engine Start Button

Turbo Stop Switch (AFT=OFF/FWD=ON)

Turbo (Saphir-5 APU)
Start Button

External Power Indicator

Engine Start Mode Switch
(under panel)
AFT: FALSE START
MIDDLE: START
FWD: COLD CRANKING

Instrument Lighting Switch
White / OFF / Red

Fire Extinguisher Button

PART 3 – COCKPIT & GAUGES

L-39C

REAR COCKPIT

Stores Indication Light
Indicates that ordnance is mounted on wing pylon



A-A Missile Indicator Light: Indicates that an air-to-air missile is loaded under a wing pylon

PART 4 – START-UP PROCEDURE

START-UP PROCEDURE

1. Battery Switch – ON (FWD)
2. Open Oxygen Valve with mousewheel - Turn Counter-Clockwise
3. Diluter Demand Switch – NORMAL (AFT)
4. Fuel Shutoff Lever – FORWARD AND GUARDED (OPEN)
5. Parking Brake – ON (bring all the way forward and ensure lever touches the black flag to set to PARKING)
6. Set desired “Dangerous Height” on radar altimeter by rotating lower left knob (recommended: 50 m)
7. Hydraulic Emergency Levers – FORWARD
8. Ensure all circuit breakers on electrical panel are ON (UP)

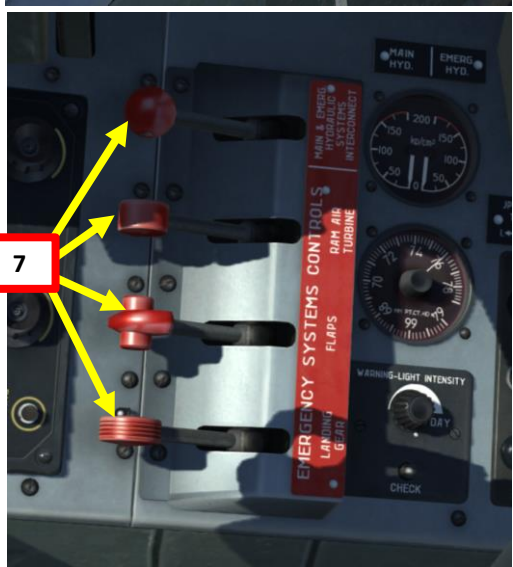
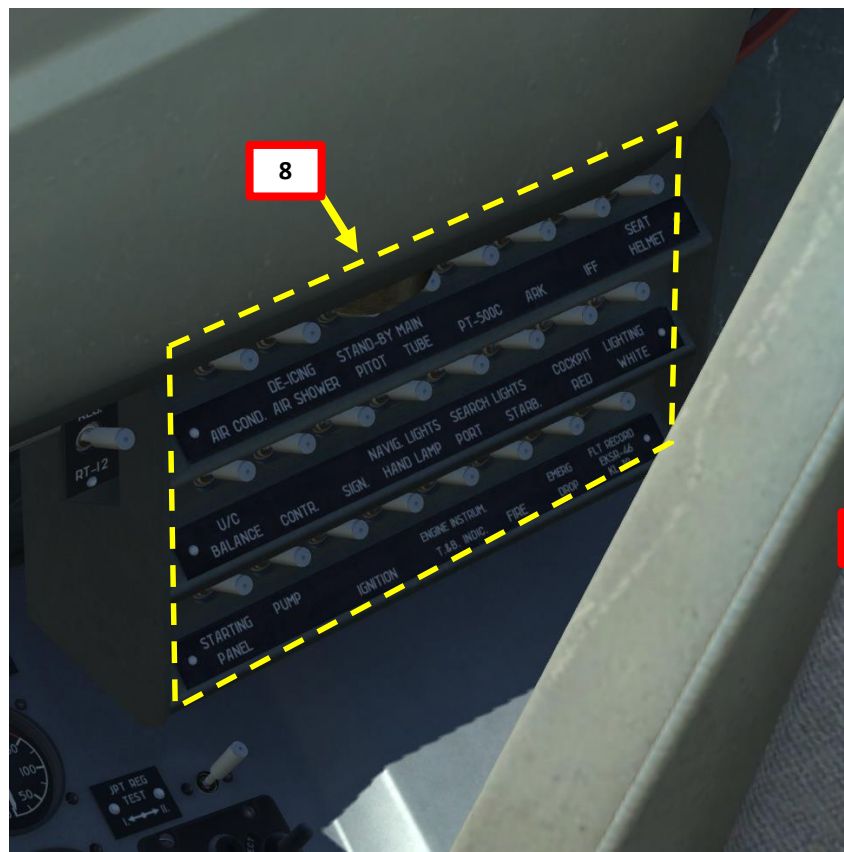
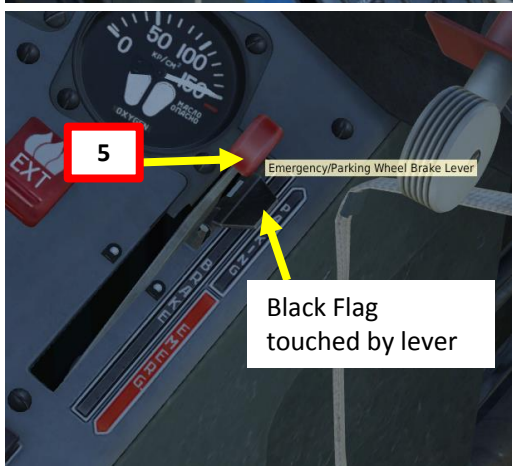
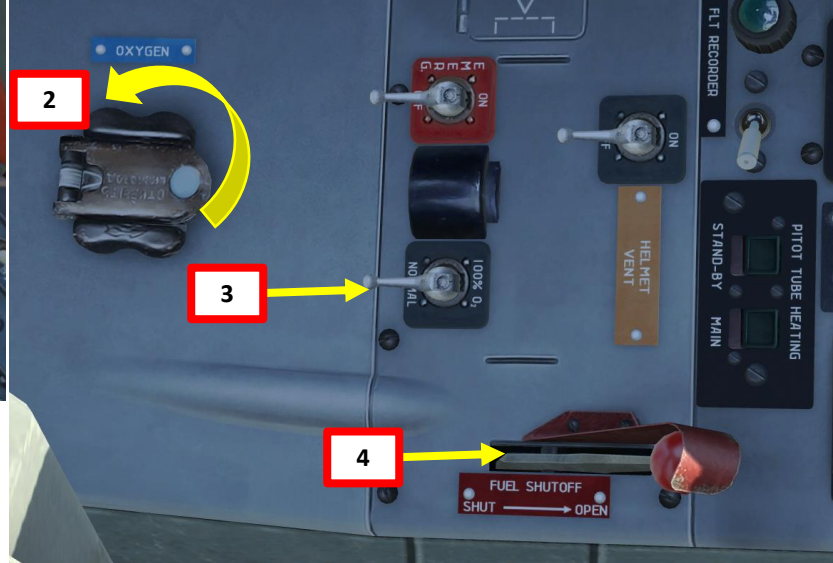

PART 4 – START-UP PROCEDURE

9. Engine Switch – ON (FWD)
10. Flip TURBO safety cover switch and press the TURBO button to start APU
11. Within 25 seconds, the “TURBO STARTER” caution light on the caution panel should illuminate to indicate that APU is ON
12. Flip ENGINE safety cover switch and press the ENGINE STARTER button for 3 seconds to start the engine
13. 3 seconds after pressing the ENGINE STARTER button, set throttle in IDLE position by pressing RAlt+HOME
14. Observe engine parameters rising and ensure your N1 (RPM) reaches IDLE setting at 56 % RPM (N2 should be around 30 % RPM). TURBO (APU) will automatically shut down and TURBINE STARTER indication will extinguish.

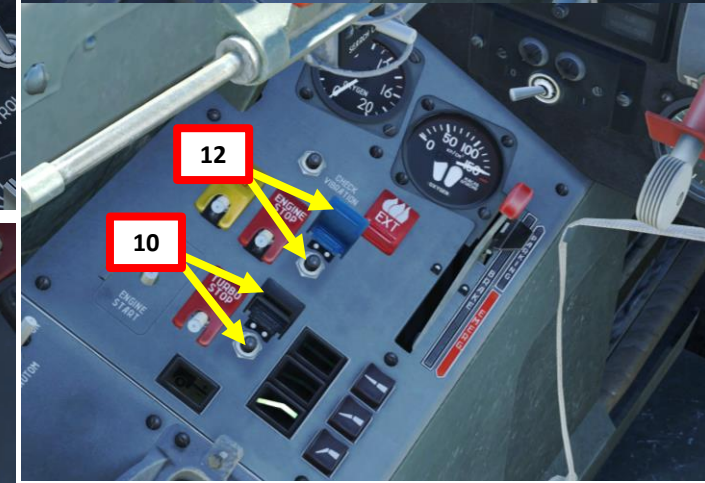
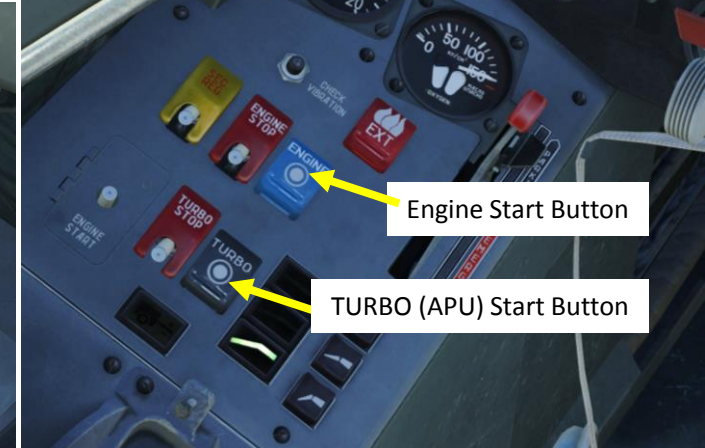
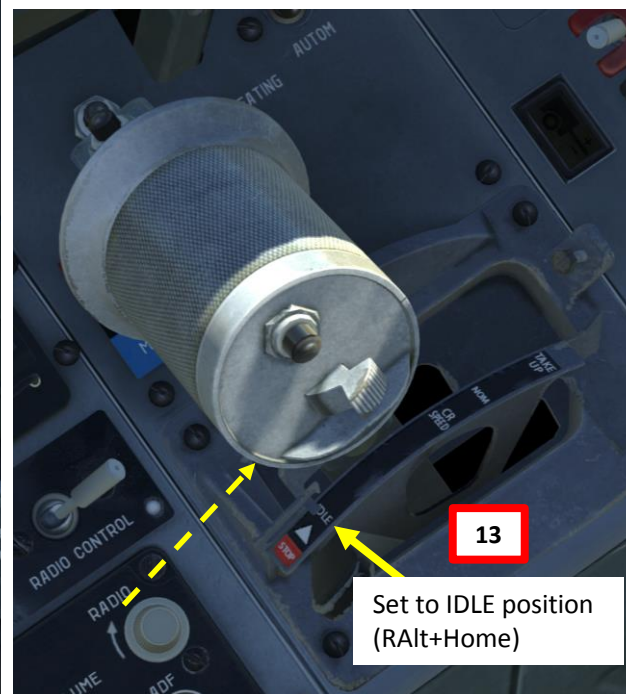
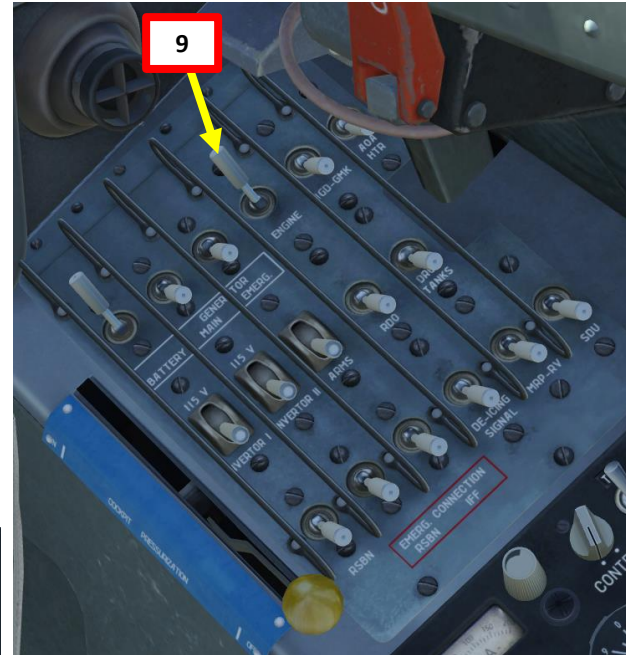

PART 4 – START-UP PROCEDURE

15. Close canopy by pulling on the canopy handle (right click)
16. Lock Canopy by pushing the Lock Handle forward
17. Push Cockpit Pressurization Handle forward (ON)
18. Set Main Generator and Emergency Generator switches to ON (FWD)
19. Set Inverter #1 and Inverter #2 switch to ON
20. Set the rest of the ACB (Automatic Circuit Breakers) to ON (FWD) on the front electrical panel
21. Main and Standby Pitot Tube Heating – ON (on left console panel next to throttle)

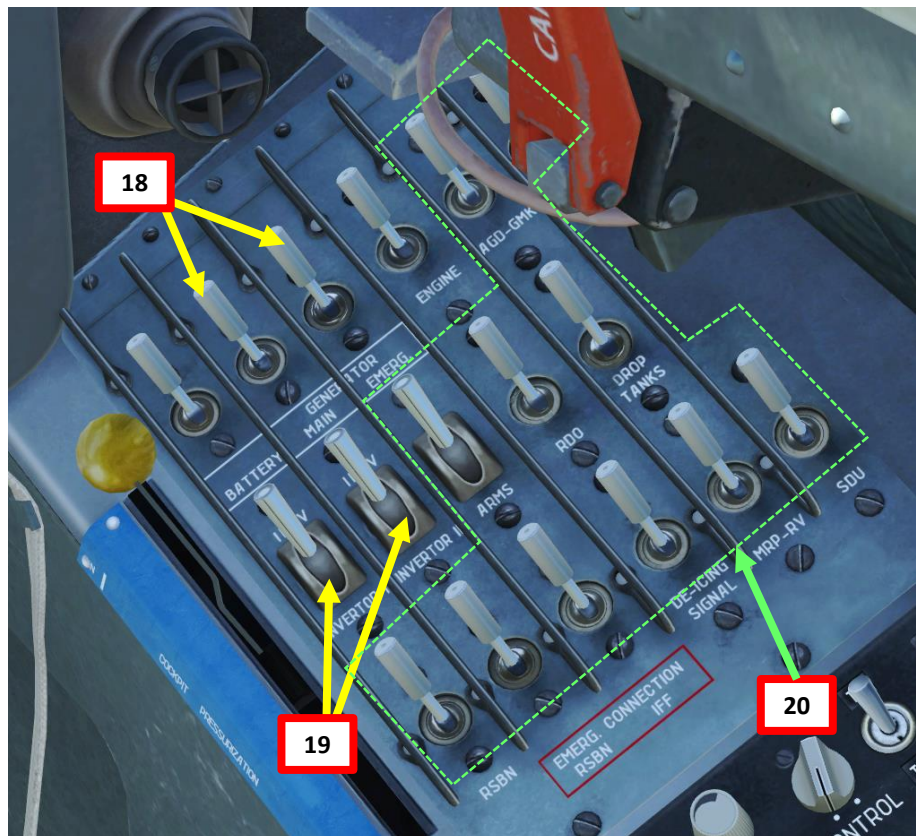
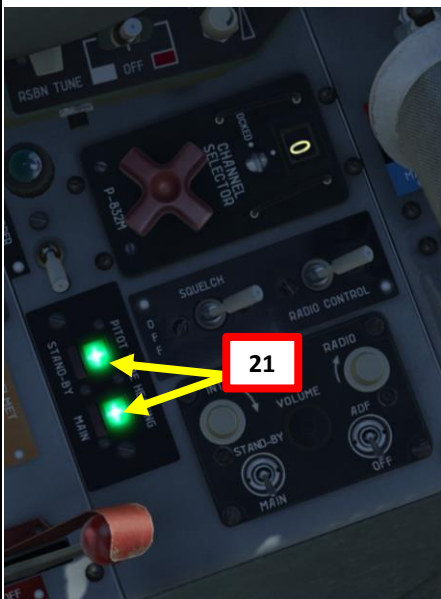
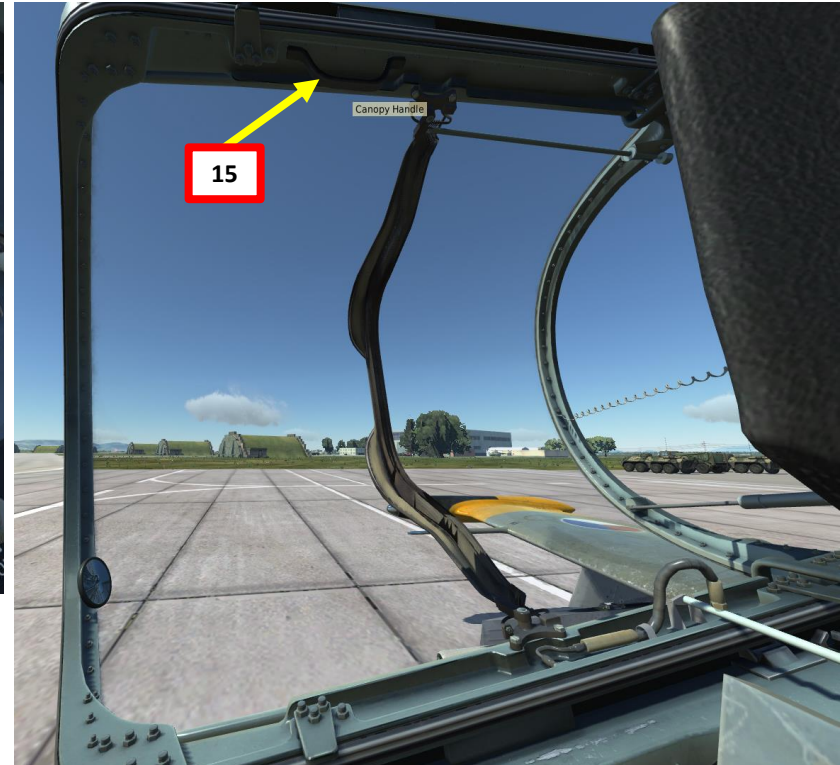
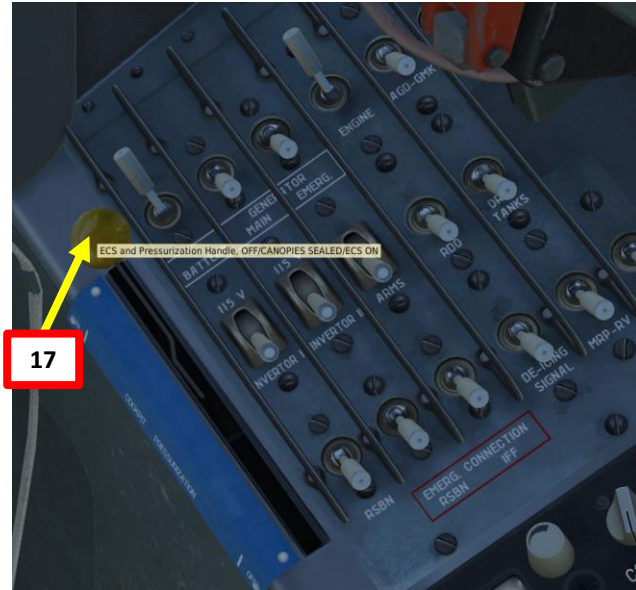

PART 4 – START-UP PROCEDURE

22. An automated “Dangerous Altitude” test will be performed on the radar altimeter. You should hear an audio warning sound.
23. Set your “Dangerous Altitude” index to 0 to remove light and set it back to your desired altitude as done previously.
24. Parking Brake – DISENGAGED (bring lever aft and ensure lever does not touch the black flag to set to disengage parking brake)
25. Steer aircraft towards the taxiway and taxi to runway.

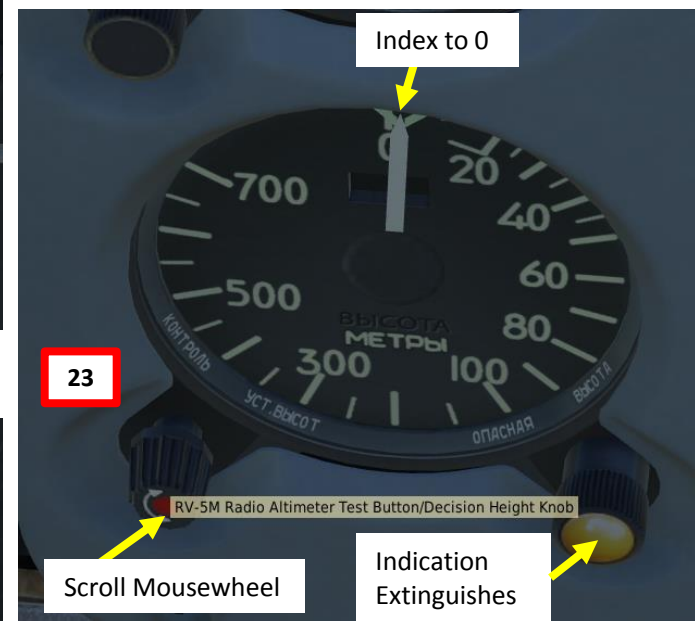

PART 5 - TAKEOFF

TAKEOFF

1. Set your flaps to the TAKEOFF position (middle) and ensure airbrakes are retracted.
2. Hold down brakes, MAX throttle.
3. Release brakes and start rolling.
4. Gently start pulling on the stick to get the nosewheel up at 150 km/h.
5. Rotate at 190-200 km/h.
6. Landing Gear UP.
7. Flaps UP.
8. Start climbing at 350 km/h.

Caution: Flaps will automatically retract themselves at airspeeds over 310 km/h.

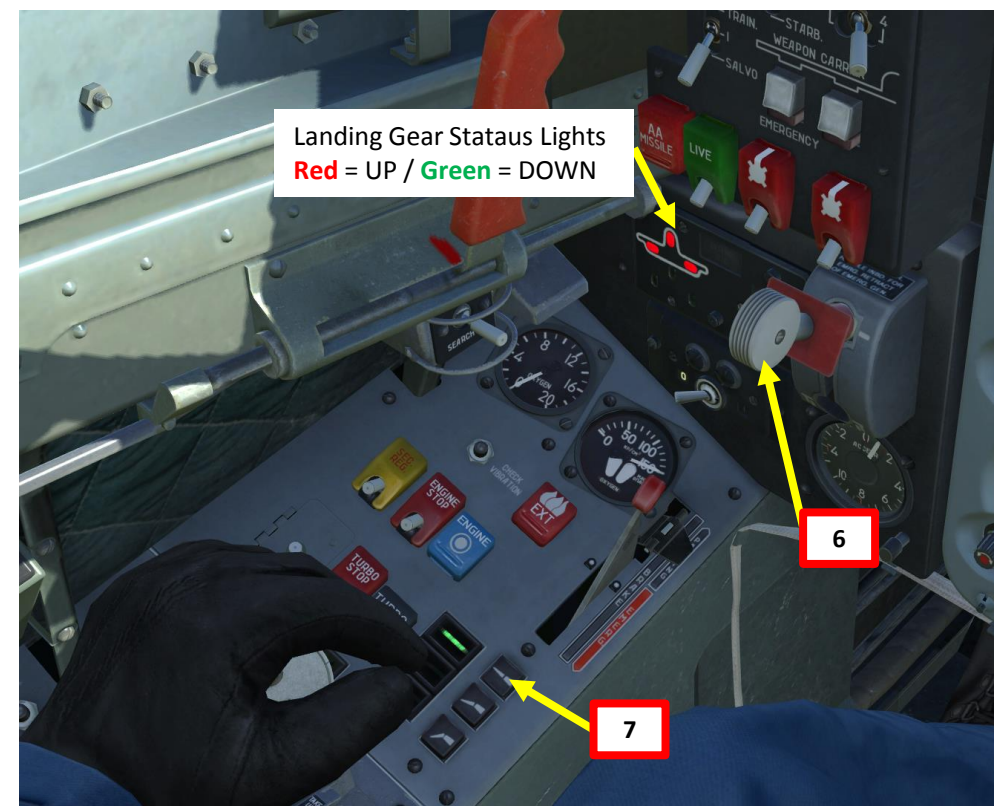

NORMAL 360-DEGREE LANDING APPROACH

1. Initial Approach
 - Altitude: 500 m
 - Airspeed: 450+ km/h
 - Airbrakes and throttle as required
2. Downwind leg
 - Altitude: 500 m
 - Airspeed: Below 300 km/h
 - Lower Landing Gear
 - Flaps at TAKEOFF position (MID)
 - Airbrakes Retracted
3. Base Leg
 - Altitude: 400 m
 - Airspeed: 280 km/h
 - Use around 95-100 % throttle to maintain airspeed
4. Before Glide Path Final Approach (Final Turn)
 - Altitude: 250 m
 - Airspeed: 260 km/h
 - Flaps at LANDING position (fully extended)
5. On Glide Path Final Approach
 - Airspeed: 230 km/h MINIMUM
 - Throttle at 70 %
6. Touchdown speed at 180 km/h. Flare gently.

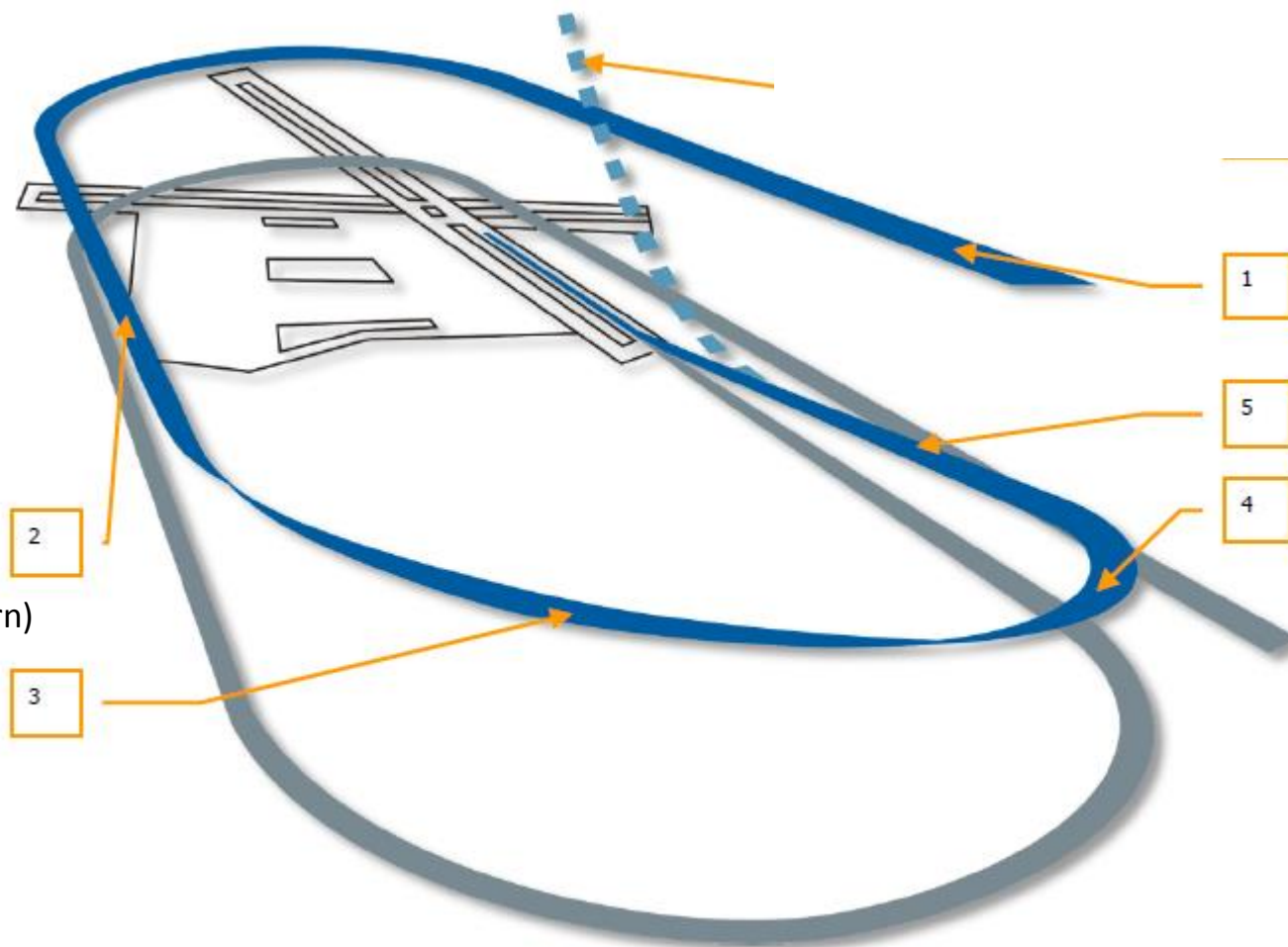

Figure 383. Circling 360-degree Landing Approach

The engine installed on the L-39 is the Ivchenko AI-25TL turbofan.

Compressor: Axial, 3 fan/low-pressure compressor stages, 9 high-pressure compressor stages

Combustors: Annular

Turbine: 2 high pressure turbine stages, 1 low-pressure turbine stage

Developed since 1965, the AI-25 can generate a maximum thrust of 16.9 kN (3,800 lbf) with a thrust-to-weight ratio of 4.9:1. In comparison to modern jets, the L-39 is a bit underpowered.

The AI-25TL twin-shaft turbofan engine is installed on the airplane.

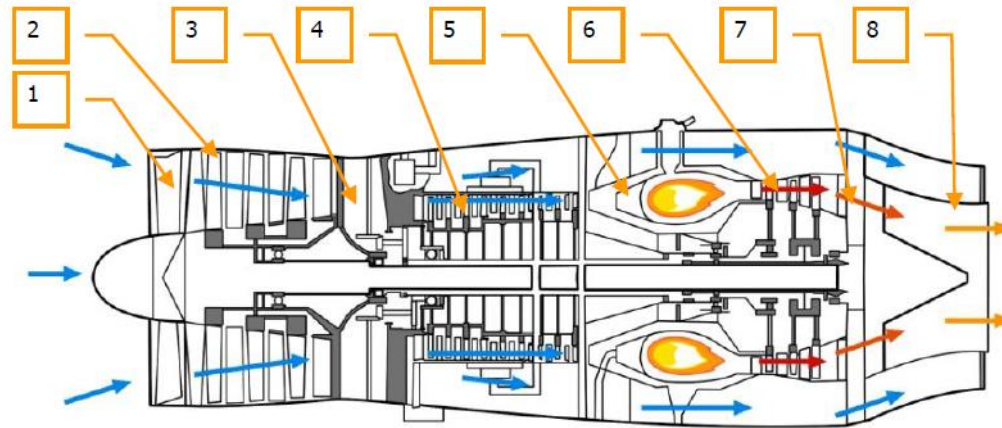

Figure 71: AI-25TL engine

1. Fan
2. Low pressure axial flow compressor (LPC)
3. Air flow separator
4. High pressure axial flow compressor (HPC)
5. Combustion chamber
6. Turbine rotor
7. Mixing chamber
8. Jet nozzle



The engine has a JPT (Jet Pipe Temperature) regulator, which is basically an EGT (Exhaust Gas Temperature) overheat protection system. This automated controller will regulate fuel flow sent to the combustion chamber to avoid damaging the engine.

- N1 Tachometer: HPC RPM (High-Pressure Compressor rotation speed)
- N2 Tachometer: LPC RPM (Low-Pressure Compressor rotation speed)
- EGT Thermometer: Exhaust Gas Temperature in deg C



Engine Main Specification and Restrictions

Parameters	Operation mode			
	Takeoff	Nominal	Cruise	Idle
Thrust, kgF	1720	1500	1275	≤135
RPM, %	106,8	103,2	99,6	56±1,5
Maximum EGT, °C				
on ground	660	625	590	600
in flight	At H≤8000 m 685 (705*) At H>8000 m 715	650 670*	615 635*	600
Maximum fuel pressure, kgF/cm ²	65	65	65	65
Oil temperature at engine inlet, °C	-5 to +90	-5 to +90	-5 to +90	-5 to +90
Maximum operational altitude, m	10.000	12.000	12.000	12.000
Maximum duration of continuous operation, min	20	Unlimited	Unlimited	On ground: 30 In flight: unlimited
Engine response time when throttle handle is moved from idle to max mode, s	9-12			
Engine startup time on ground and in flight, s	≤50			
Maximum allowed EGT during startup, °C				
on ground	550			
in flight	600			

* when anti-icing system is enabled, EGT increases at 25-30°

WHAT TO DO IN CASE OF ENGINE FAILURE

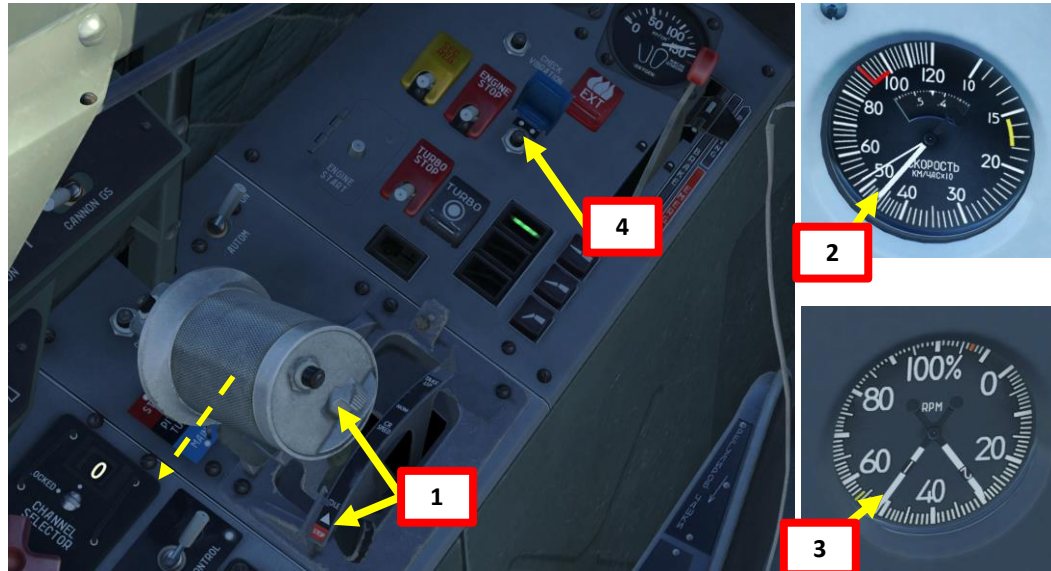

If N1 is higher than 15%, a **windmilling engine** restart can be performed

Windmilling: aircraft airspeed is sufficient to provide enough airflow to drive the compressor blades even without combustion

1. Throttle back to STOP position
2. Maintain airspeed greater than 430 km/h
3. Ensure engine RPM is higher than 15 %
4. Press the ENGINE starter button for 2 seconds
5. After 3-6 seconds after the ENGINE starter button was pressed, move throttle from STOP to IDLE position
6. Progressively throttle up as engine RPM increases

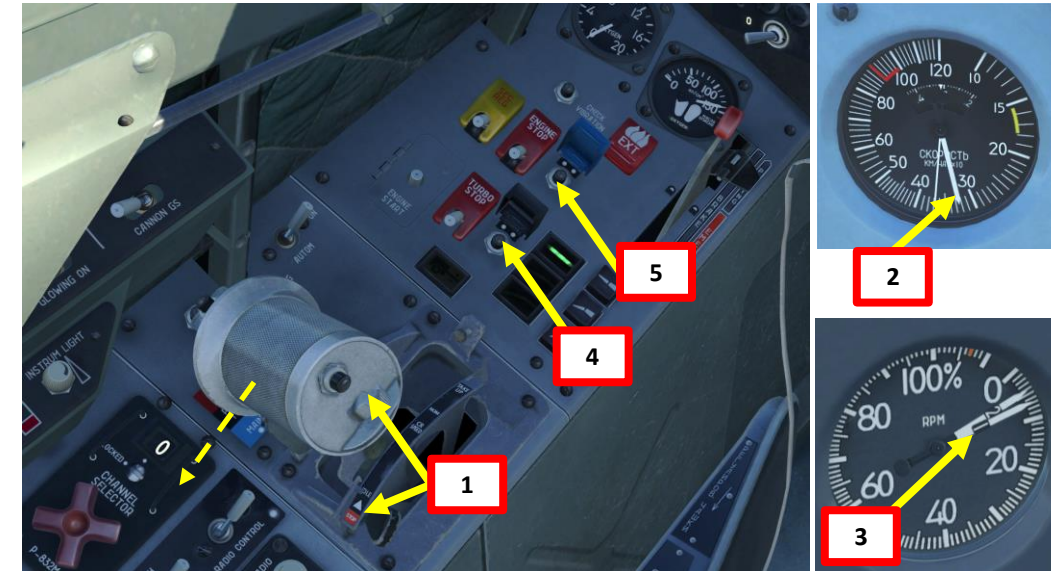
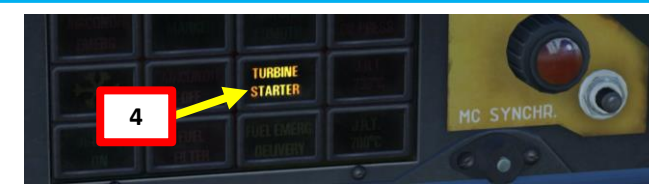

If N1 is lower than 15 %, an **APU-assisted engine** restart is required

1. Throttle back to STOP position
2. Maintain airspeed between 300-350 km/h
3. Ensure engine RPM is lower than 15 %
4. Press the TURBO (APU start) button for 2 seconds
5. When the TURBINE STARTER caution is on, press the ENGINE starter button for 2 seconds
6. After 3-6 seconds after the ENGINE starter button was pressed, move throttle from STOP to IDLE position
7. Progressively throttle up as engine RPM increases

FUEL SYSTEM

The fuel system consists of the main fuel system and wingtip tanks' system.

- Main fuel system: 5 fuselage tanks (total capacity of 1100 liters (825 kg)).
- Wingtip tanks: 2 tanks (capacity of 100 liters each).
- Max total fuel load: (1200 liters) 975 kg.

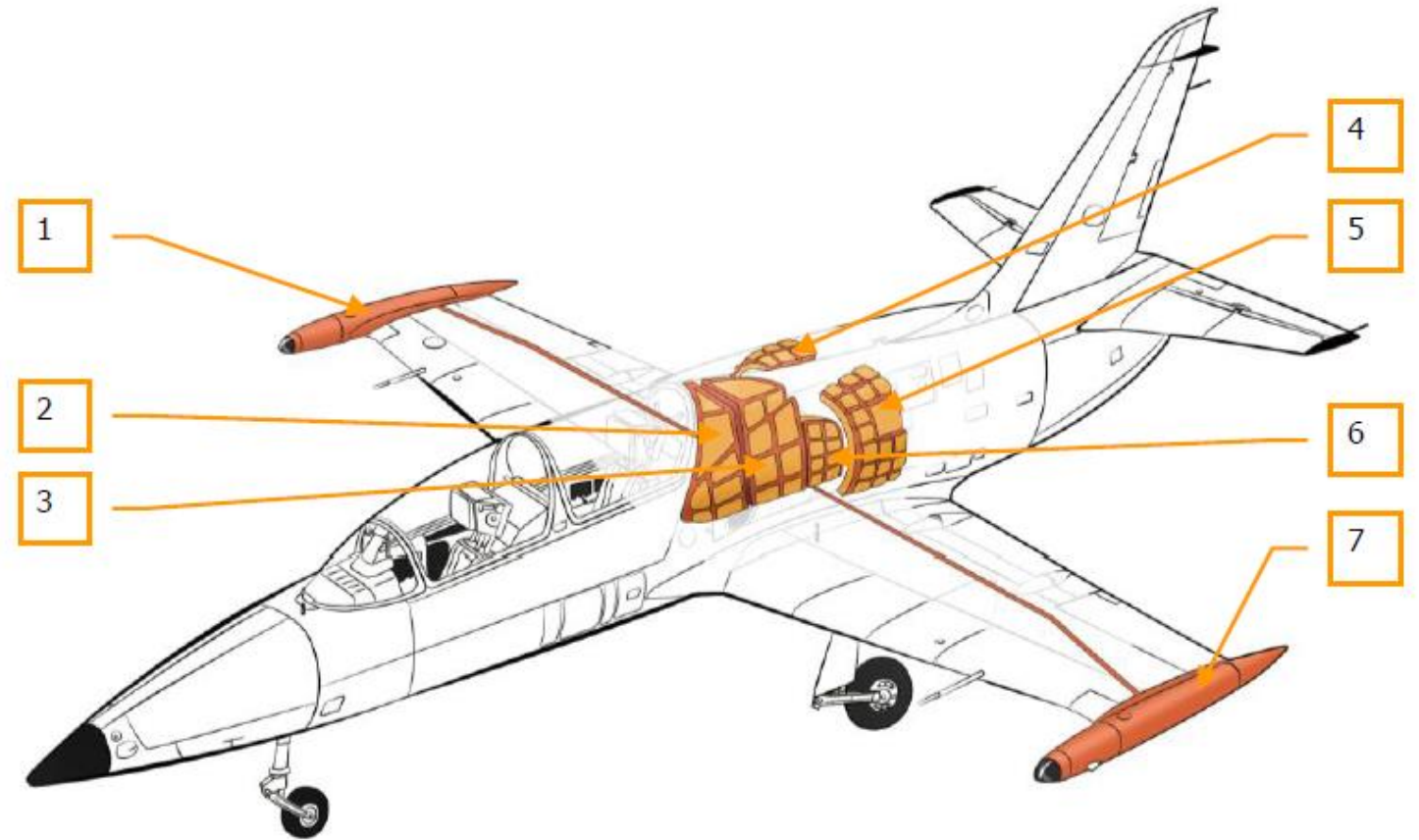

Figure 63: Fuel tanks

1. Right wingtip tank (100 l)
2. Fuselage tank #1 (260 l)
3. Fuselage tank #2 (365 l)
4. Fuselage tank #3 (135 l)
5. Fuselage tank #4 (135 l)
6. Fuselage tank #5 (205 l), feed tank
7. Left wingtip tank (100 l)

PART 8 – FLIGHT CHARACTERISTICS

TABLE OF STALL SPEEDS

Configuration		Without Stores		With Stores	
Aircraft Gross Weight (kg)		3,700	4,500	4,600	4,700
Flaps Deflection + Landing Gear Setting	0 deg LG retracted	172	190	196	198
	25 deg LG extended	157	173	182	184
	44 deg LG extended	148	163	174	176

TABLE OF MAX ALLOWABLE SPEEDS

	Flaps (Landing)	Landing Gear (Extended)
Airspeed (km/h)	310	340

FLIGHT CHARACTERISTICS I-39

Main specifications			
1. Maximum allowed true air speeds in horizontal flight (flight weight is 4000 kg):			
a) engine operating at maximum thrust ($n_{1hpc} = 106,8 \pm 1\%$)			
	at ground level	km/h	702*
	at 5000 m	km/h	757*
	at 6000 m	km/h	760*
	at 10000m	km/h	737
b) engine operating at nominal thrust ($n_{1hpc} = 103,2 \pm 1\%$)			
	at ground level	km/h	640*
	at 5000 m	km/h	712*
	at 6000 m	km/h	720*
	at 10000m	km/h	694*
2. Maximum vertical speeds (take off weight is 4300 kg):			
a) engine operating at maximum thrust ($n_{1hpc} = 106,8 \pm 1\%$)			
	at ground level	m/s	22
	at 6000 m	m/s	10,8
	at 10000m	m/s	3,4
b) engine operating at nominal thrust ($n_{1hpc} = 103,2 \pm 1\%$)			
	at ground level	m/s	16,3
	at 6000 m	m/s	8
	at 10000m	m/s	2,6
3. Service ceiling (standard conditions, take off weight 4300 kg)			
		m	11 500
4. Minimum time required for reaching altitudes (standard conditions, take off weight 4300 kg)			
a) engine operating at maximum thrust ($n_{1hpc} = 106,8 \pm 1\%$)			
	6000 m	min	6,4
	10000 m	min	16,9
	service ceiling, when from 10000m engine operates at nominal thrust	min	40
b) engine operating at nominal thrust ($n_{1hpc} = 103,2 \pm 1\%$)			
	6000 m	min	8,6
	10000 m	min	22,4
	service ceiling	min	40,8
5. Maximum range and duration of flight, when flying at 5000 m with 5% remaining fuel			
- with empty wing tanks is 850 km and 2 h 11 min			
- with full wing tanks 1015 km and 2 h 35 min.			
6. Take off roll on paved runway with engine operating at maximum thrust needed to reach take off speed of 185-190 km/h is 480-530 m.			
7. Landing roll on paved runway with use of gear brakes when landing with IAS of 180 km/h is 650-690 m.			

*: speeds listed here are in compliance with standard conditions (ISA).

PART 9 – WEAPONS & ARMAMENT

ARMAMENT OVERVIEW

AIR-TO-AIR MISSILES

TYPE	DESCRIPTION
R-60M	“Aphid” missile – Infrared Homing Range: 7 km max / 2 km effective
R-3S	“Atoll” missile – Infrared Homing Similar to AIM-9B Sidewinder Range: 8 km max / 4 km effective

ROCKETS

TYPE	DESCRIPTION
UB-16	16 x S-5KO rockets
S-5KO	Caliber: 57 mm

GUNS

TYPE	DESCRIPTION
PK-3	7.62 mm machinegun pod 3 machineguns per pod
GS-23L	Twin-Barrel 23 mm cannon 150 cartridges Effective range: 2 km

BOMBS

TYPE	DESCRIPTION
FAB-100	100 kg general-purpose bomb
FAB-250	250 kg general-purpose bomb
OFAB-100 JUPITER	100 kg high-drag (parachute) bomb
P-50T	50 kg practice bomb
SAB-100	Night Illumination Flare

MISCELLANEOUS

TYPE	DESCRIPTION
SMOKE POD	Smoke Pod – External pod or inside engine exhaust
FUEL TANK (150 L)	150 L drop tank
FUEL TANK (350 L)	350 L drop tank

PART 9 – WEAPONS & ARMAMENT

TUTORIAL - BOMBS

Note: This example is done for bombs mounted on INNER pylons. You can easily adapt it for OUTER pylons, or for both INNER and OUTER pylons.

1. Set MASTER ARM (ARMS) switch ON (UP) on electrical CB panel
2. Set ASP-FPK switch ON (UP) to turn on gunsight on armament panel
3. Set LAUNCH switch ON (UP) on armament panel to power stick trigger
4. Set BOMBS switch ON (UP) on armament panel (this circuit powers both missile and rocket pads)
5. Select INNER weapon carriers on front dash.
6. Set Bomb Mode selector switch to desired bomb drop mode (I personally go for “single bomb drop”).
7. Missile (A/A) and Bomb Release Mode Switch:
 - Set to PORTSIDE to drop a SINGLE bomb or STARBOARD to drop TWO bombs.
8. Flip DOWN Weapons Safety Cover switch on stick (“Weapon Fire Button Safety” control)
9. Fire Weapon (“Weapon Fire Button” control)

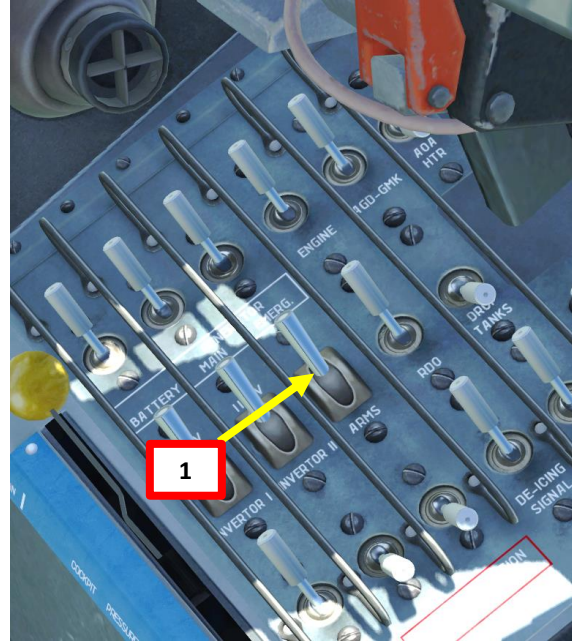

Weapon Safety ON



Weapon Safety OFF

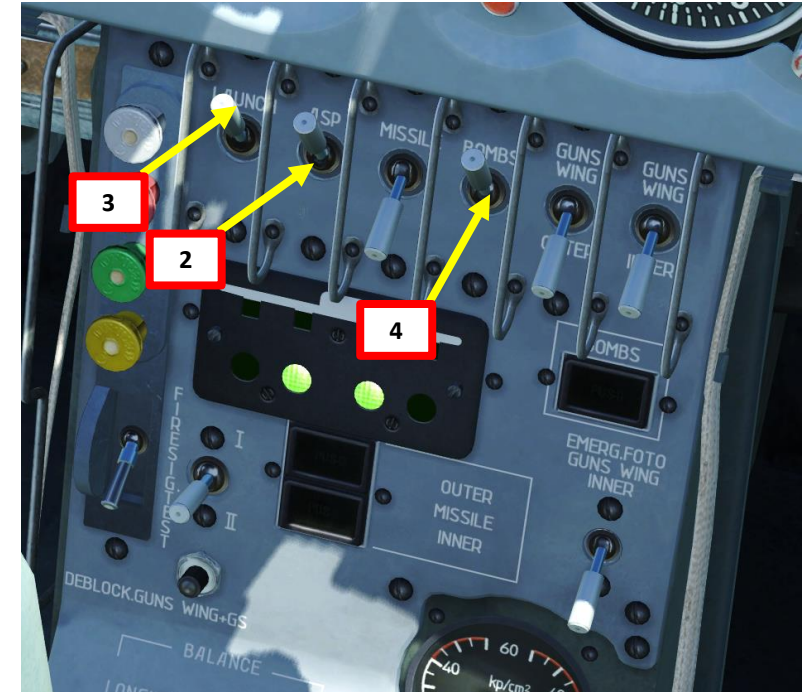
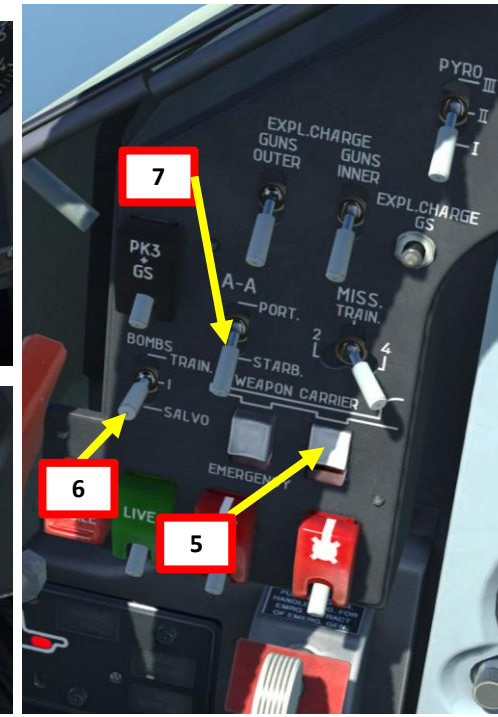

PART 9 – WEAPONS & ARMAMENT

TUTORIAL – GS-23L CANNON

1. Set MASTER ARM (ARMS) switch ON (UP) on electrical CB panel
2. Set CANNON GS switch ON (FWD) on missile panel
3. Set ASP-FPK switch ON (UP) to turn on gunsight on armament panel
4. Set LAUNCH switch ON (UP) on armament panel to power stick trigger
5. Set the “PYRO” switch to desired position to choose which pyrotechnical explosive cartridge will be used to reload gun
6. Press the “EXPLOSIVE CHARGE GS” button on front dash to reload the gun
7. Flip DOWN Weapons Safety Cover switch on stick (“Weapon Fire Button Safety” control)
8. Fire Weapon (“Weapon Fire Button” control) **when you are within firing parameters**

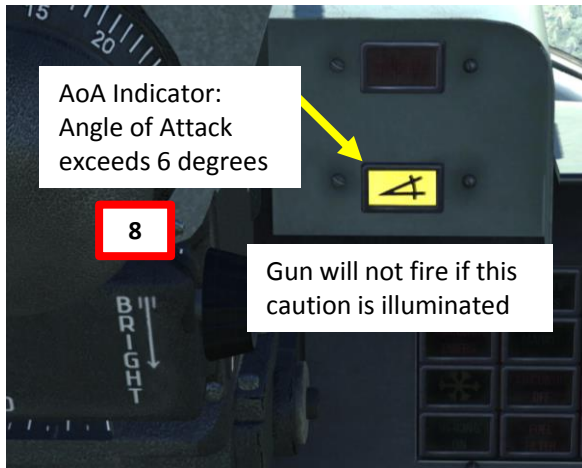
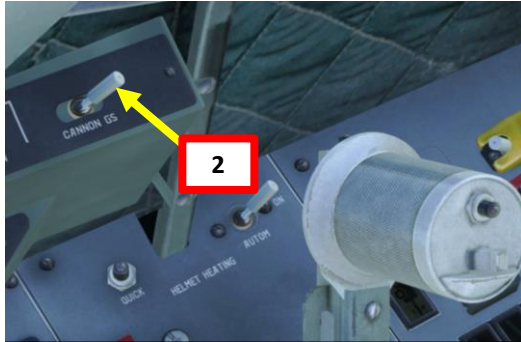

Firing the gun is only possible in these conditions:

- The front landing gear is retracted
- Speed is no less than 400 km/h
- The angle of attack does not exceed 6 degrees
- The positive G is no more than 6
- The negative G is no more than -2

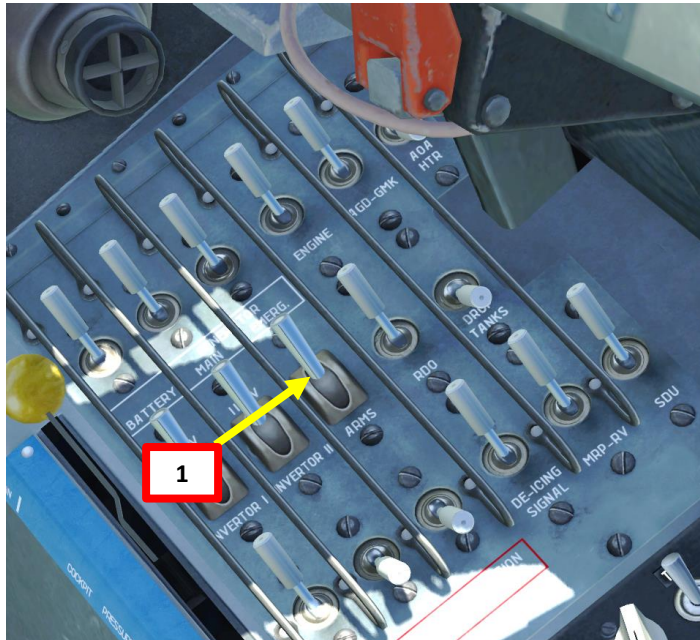

Weapon Safety ON



Weapon Safety OFF

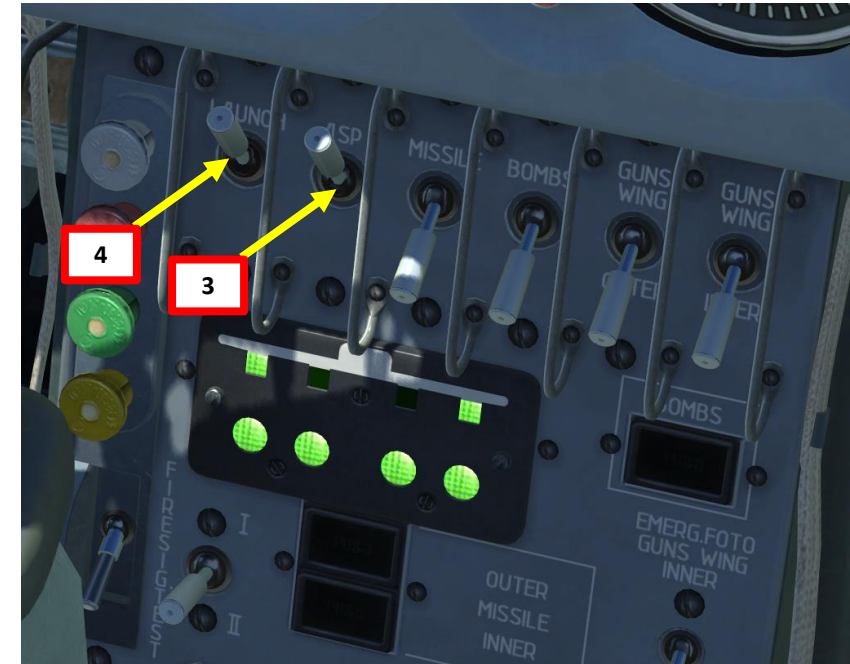
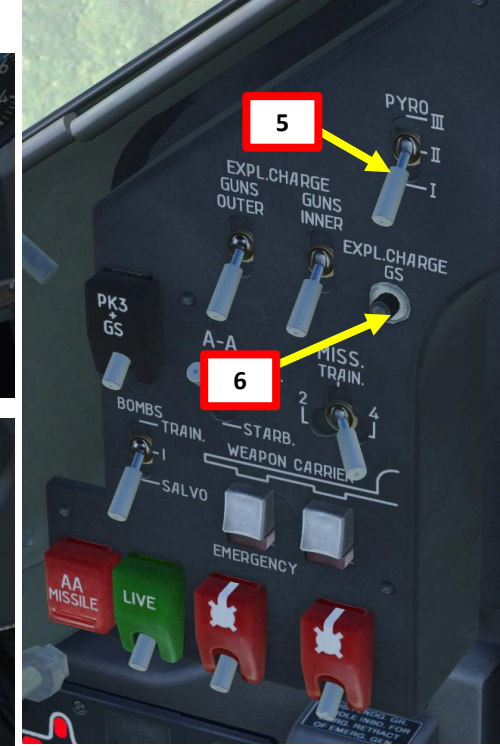

PART 9 – WEAPONS & ARMAMENT

TUTORIAL – GS-23L CANNON

Some important notes on the GS-23L Cannon:

- A fixed gyro gunsight is recommended for ground strikes
- The GS-23L cannon is not recommended for air-to-air combat
- When firing the cannon, engine RPM will decrease and possibly shut down if you fire for too long. Quick bursts are recommended to maintain engine RPM.
- This sudden loss of RPM is actually an automated protective measure of the AI-25TL engine to prevent engine surge or flameout when firing the cannon. The GS-23 smoke and gasses generated when firing the gun are directly ingested by the engine.
- This loss of power must be taken into account when going on gun run in a dive.
- If you want to fire the GS-23L Cannon in conjunction with PK-3 machinegun pods:
 - a) Perform steps 1) to 6) of the GS-23L tutorial
 - b) Flip UP PK-3+GS switch on the front dash (the one with the black cover)
 - c) Perform steps 1) to 9) of the PK-3 tutorial

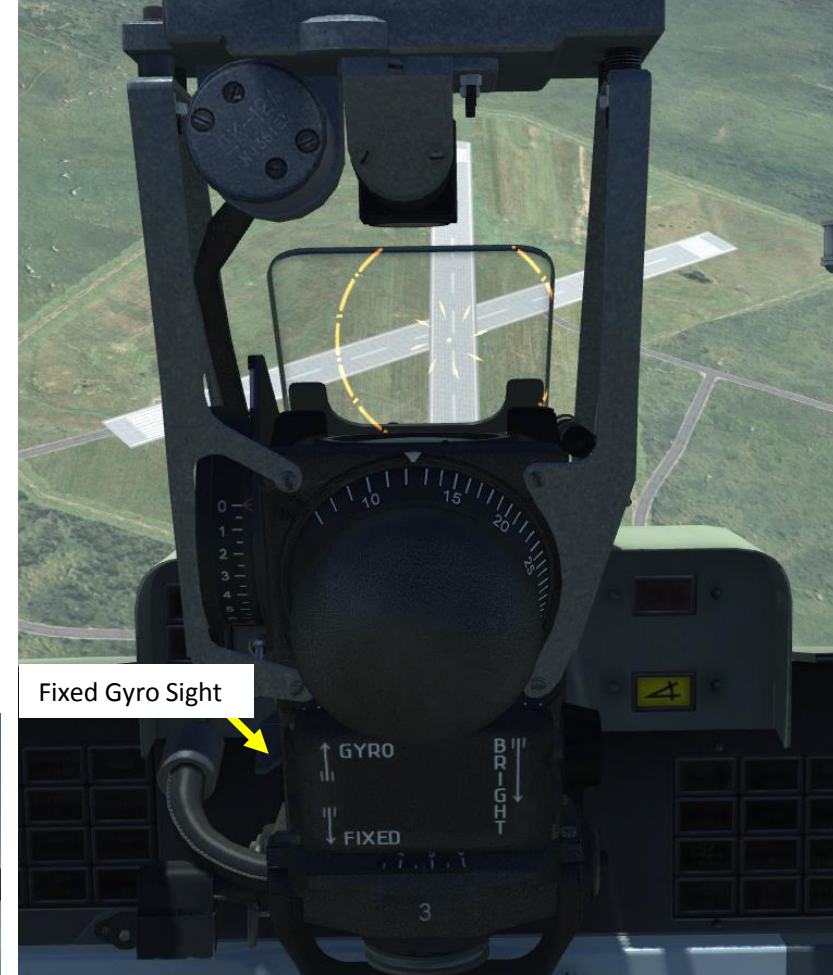
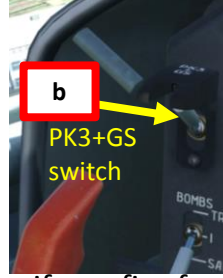

Engine RPM decreases when firing cannon

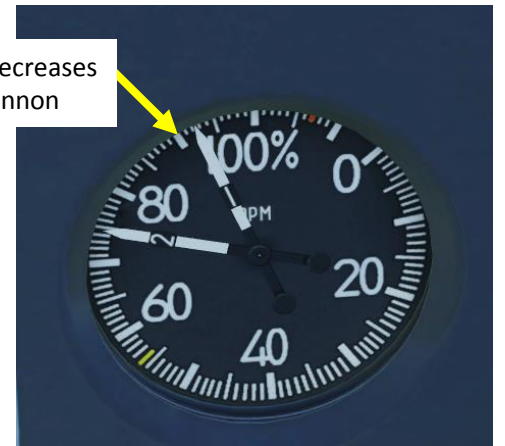

PART 9 – WEAPONS & ARMAMENT

TUTORIAL – PK-3 MACHINEGUNS

Note: This example is done for PK-3 gun pods mounted on INNER pylons. You can easily adapt it for OUTER pylons, or for both INNER and OUTER pylons, or even in conjunction with the GS-23L cannon.

1. Set MASTER ARM (ARMS) switch ON (UP) on electrical CB panel
2. Set ASP-FPK switch ON (UP) to turn on gunsight on armament panel
3. Set LAUNCH switch ON (UP) on armament panel to power stick trigger
4. Select INNER pylons on armament panel.
5. Select INNER weapon carriers on front dash.
6. Set the “PYRO” switch to desired position to choose which pyrotechnical explosive cartridge will be used to reload gun
7. Flip the “EXPLOSIVE CHARGE GUNS INNER” button UP on front dash to reload the inner guns
8. Flip DOWN Weapons Safety Cover switch on stick (“Weapon Fire Button Safety” control)
9. Fire Weapon (“Weapon Fire Button” control)

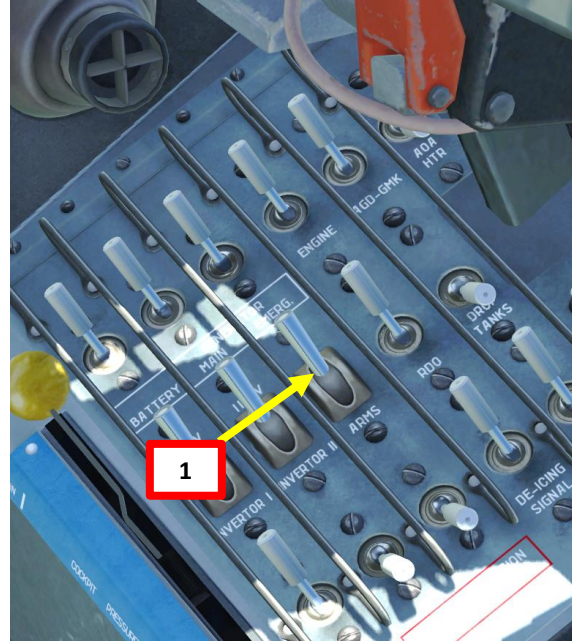

Weapon Safety ON



Weapon Safety OFF

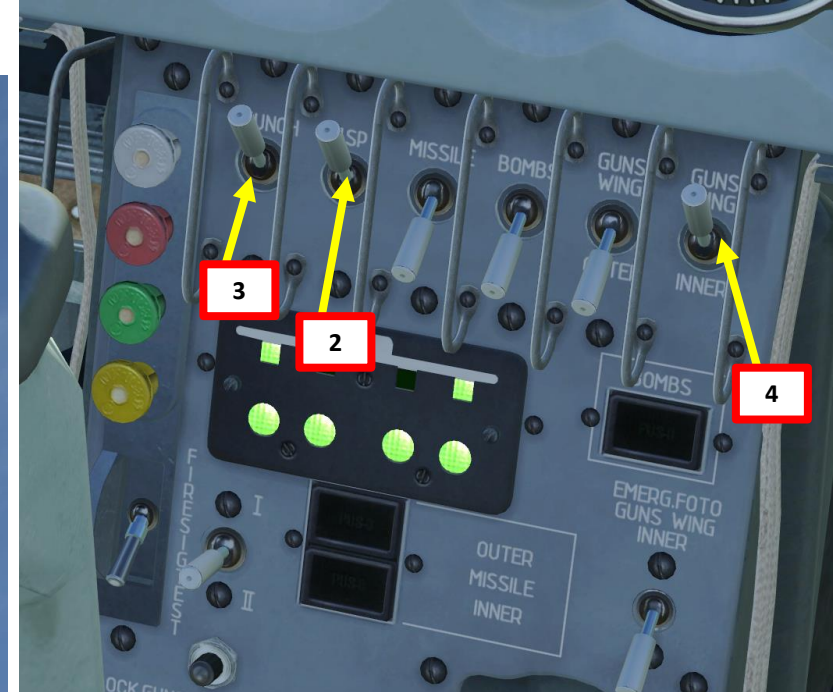
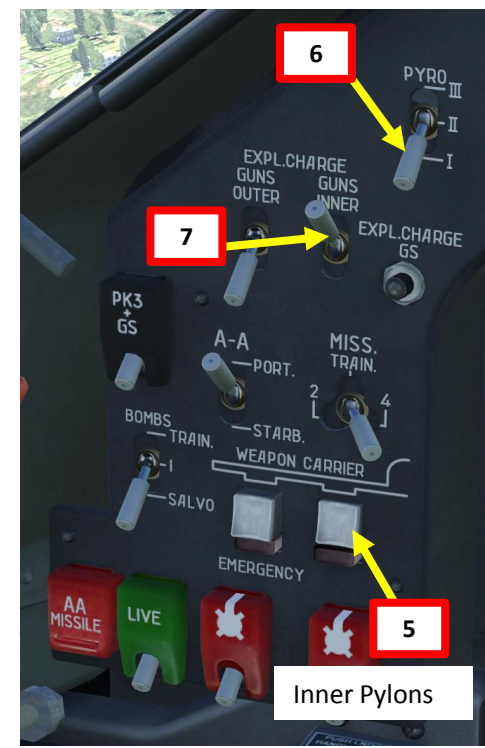

PART 9 – WEAPONS & ARMAMENT

TUTORIAL – S-5KO ROCKETS

Note: This example is done for rocket pods mounted on OUTER pylons. You can easily adapt it for INNER pylons, or for both INNER and OUTER pylons.

1. Set MASTER ARM (ARMS) switch ON (UP) on electrical CB panel
2. Set ASP-FPK switch ON (UP) to turn on gunsight on armament panel
3. Set LAUNCH switch ON (UP) on armament panel to power stick trigger
4. Set MISSILE switch ON (UP) on armament panel (this circuit powers both missile and rocket pads)
5. Select OUTER weapon carriers on front dash.
6. Set Rocket Firing Mode selector switch to either MISS. TRAIN (automatic, will fire all rockets at once), 2 rockets at once or 4 rockets at once.
7. Flip DOWN Weapons Safety Cover switch on stick (“Weapon Fire Button Safety” control)
8. Fire Weapon (“Weapon Fire Button” control)

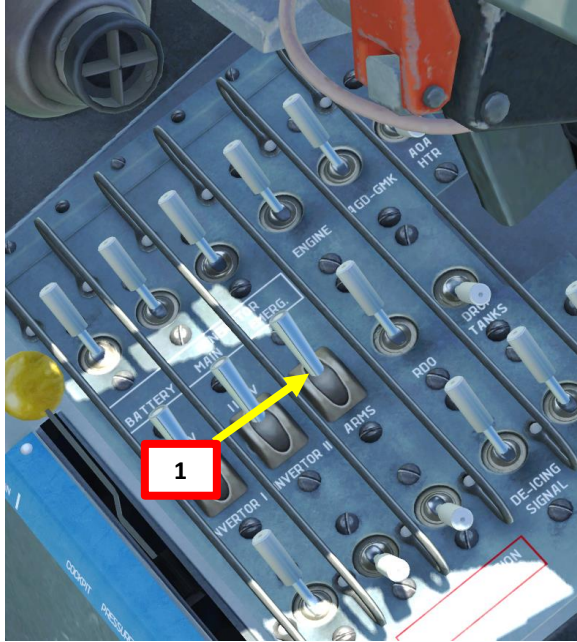

Weapon Safety ON



Weapon Safety OFF

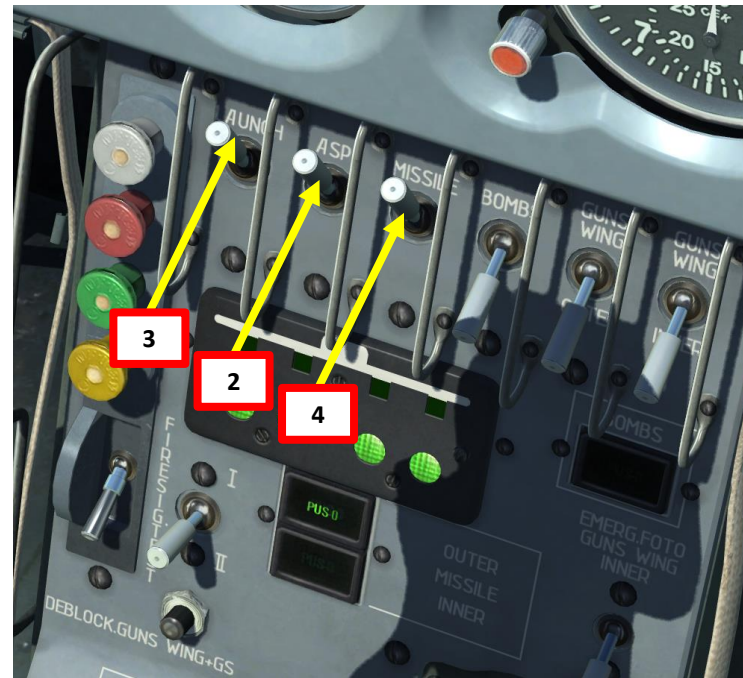
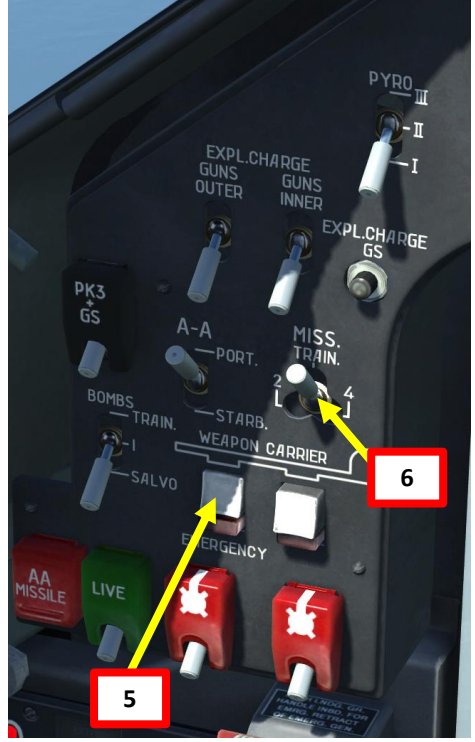

PART 9 – WEAPONS & ARMAMENT

TUTORIAL – AIR-TO-AIR MISSILES

1. Set MASTER ARM (ARMS) switch ON (UP) on electrical CB panel
2. Set HEATING SS (Missile Seeker Heating) switch ON (FWD) on missile panel
3. Set GLOWING SS (Missile Seeker Heating) switch ON (FWD) on missile panel
4. Adjust Missile Seeker Tone Volume as required on missile panel
5. Set ASP-FPK switch ON (UP) to turn on gunsight on armament panel
6. Set LAUNCH switch ON (UP) on armament panel
7. Set MISSILE switch ON (UP) on armament panel
8. Select OUTER pylons on front dash
9. Missile (A/A) and Bomb Release Mode Switch:
 - Set to PORTSIDE to launch left missile or STARBOARD to launch right missile on front dash
10. Flip DOWN Weapons Safety Cover on stick (“Weapon Fire Button Safety” control)
11. Fire Missile (“Weapon Fire Button” control) when seeker has a lock (seeker tone has a higher pitch)

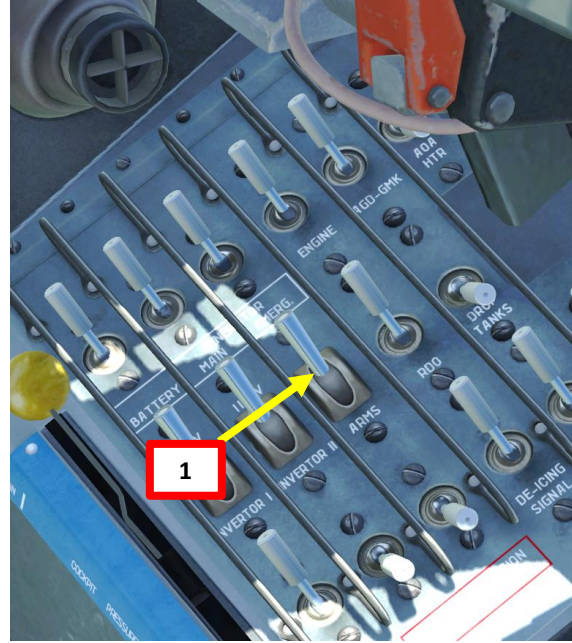

Weapon Safety ON



Weapon Safety OFF

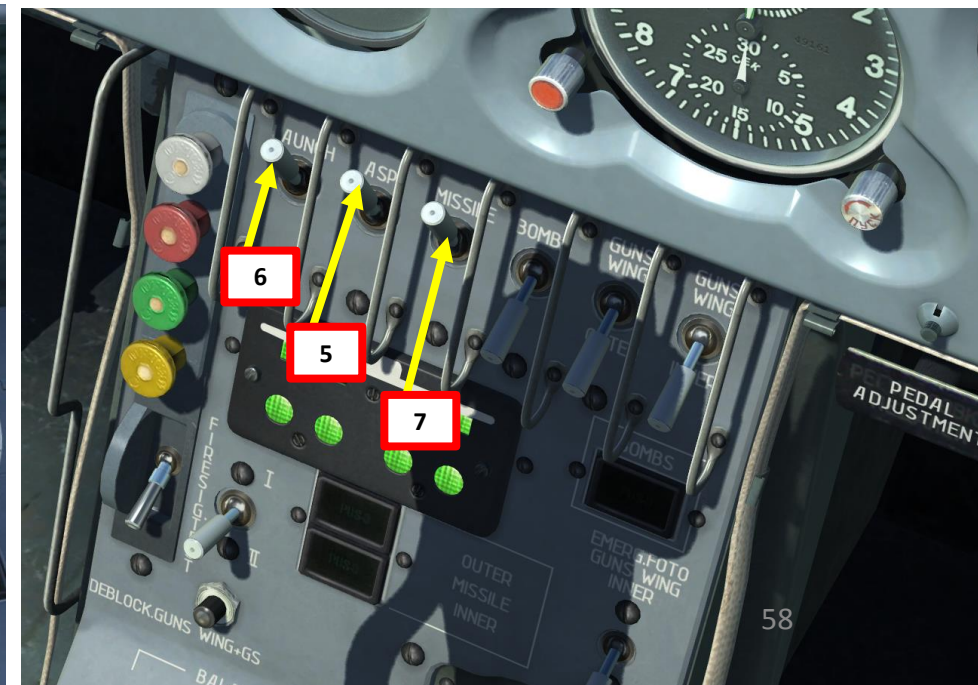
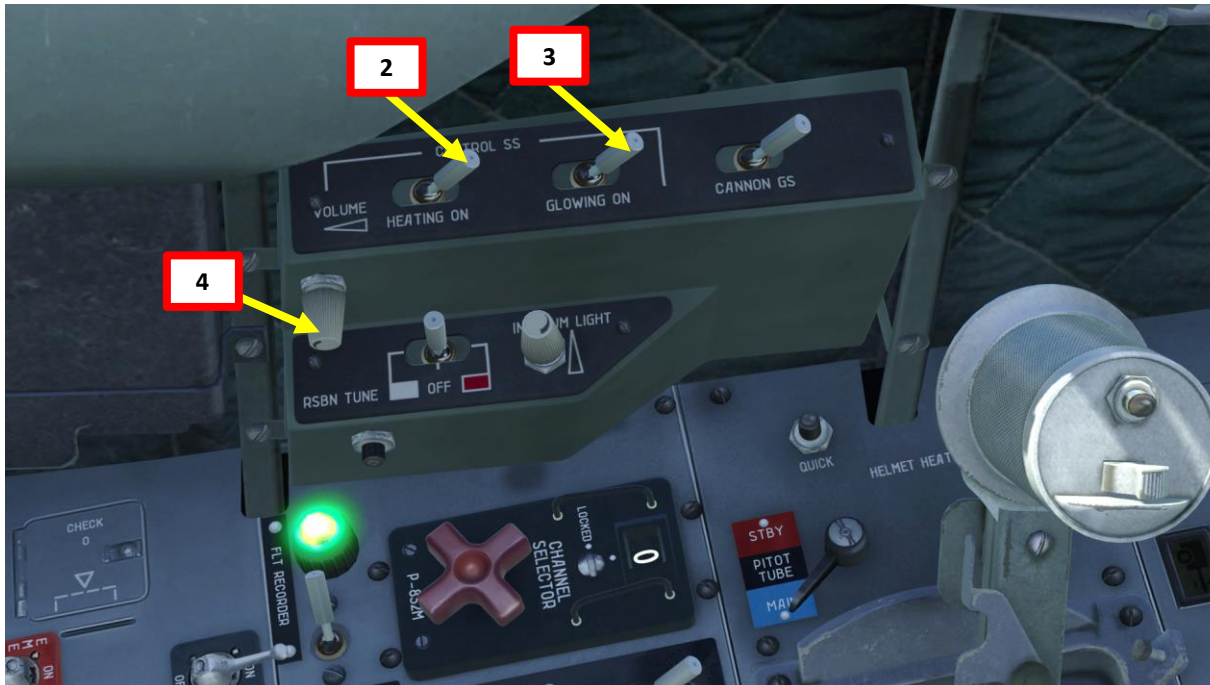
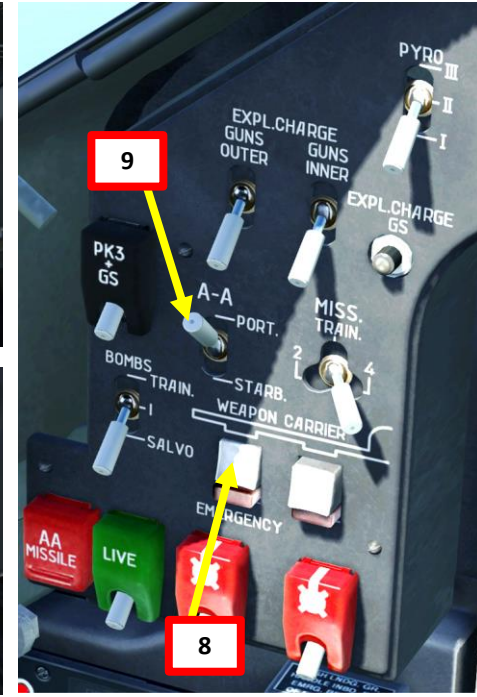

PART 9 – WEAPONS & ARMAMENT

TUTORIAL – AIR-TO-AIR MISSILES

Some important notes on the missiles equipped on the L-39:

- The R-3S and R-60 missiles equipped on the L-39 have a short range and will not track maneuverable targets
- Your air-to-air missiles should be used against big and slow air targets like bombers or tankers
- In order to get a kill, you will have to acquire the target visually. There is no on-board radar equipment to help you.
- Gather intelligence on what enemy opposition you might run into and plan ahead. The L-39 is basically outmatched by most modern jets in the game (F-15, Mirage, Su-27, MiG-29, Su-33, MiG-21, etc.), which means that you should avoid picking up fights you cannot win. You have no countermeasures system, no radar, no jammer, no RWR (radar warning receiver)... so you are basically completely “blind” and will have to rely on your sharp eagle eyes. Engaging every contact or target visually is quite a challenging task, so make sure that you never fly alone and always have a wingman by your side.



PART 9 – WEAPONS & ARMAMENT

GUNSIGHT – HOW TO DO A PROPER BOMB/ROCKET RUN

- The ASP-3NMU Gunsight can be set for a target range and a target wingspan.
- Make sure you have a “Target Distance” control mapped as shown on the screenshot on the right (it will twist the throttle grip).
- The mirror depression angle can also be adjusted.

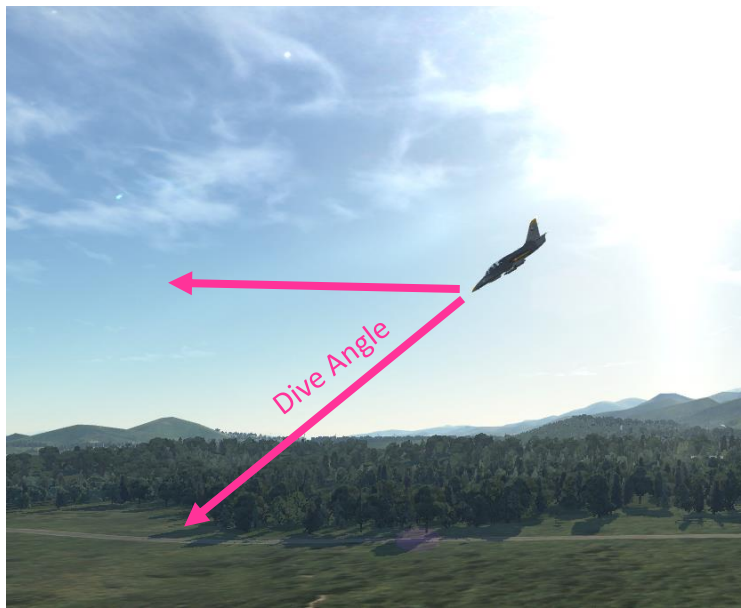
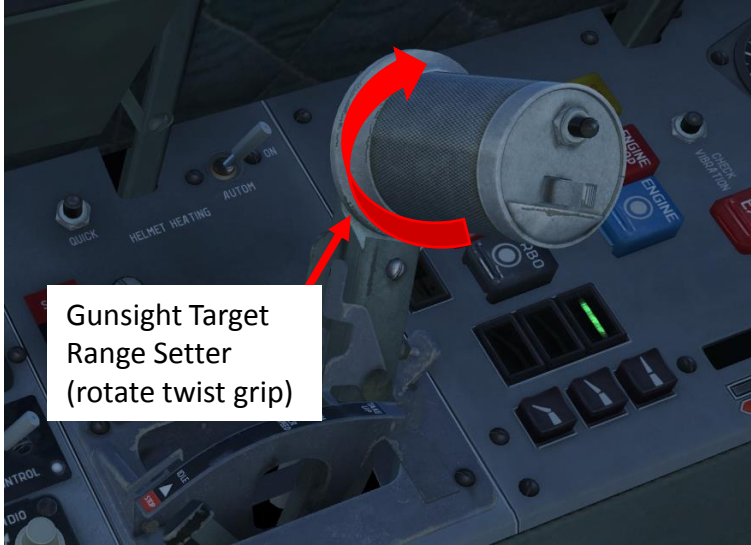

The airspeed, altitude, dive angle and gunsight settings (mirror depression angle, wingspan (target size), target distance) will be explained next page.

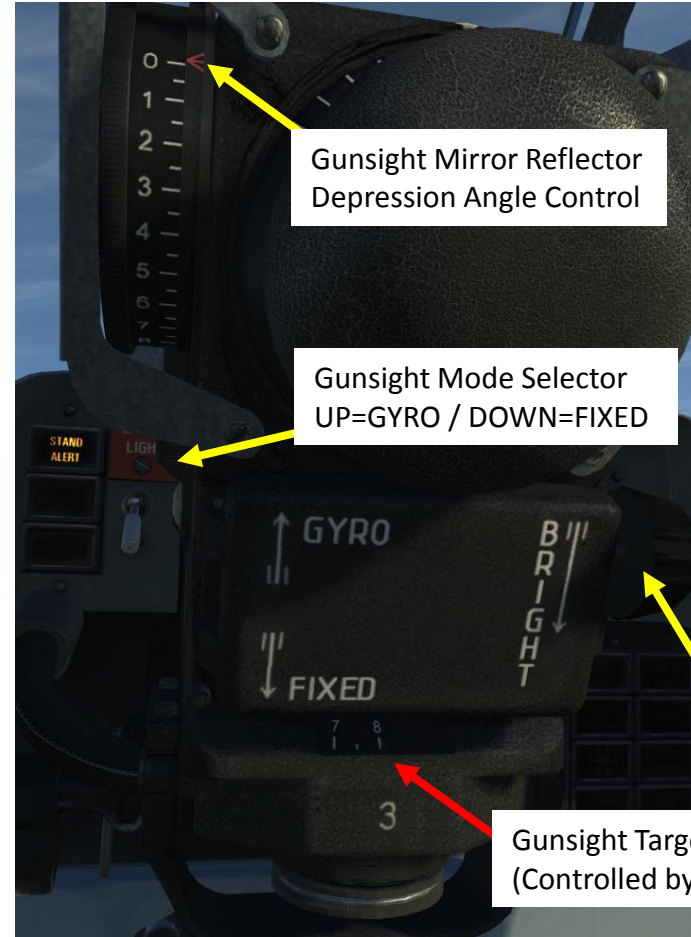

Layer	L-39ZA	All	Category	Clear category
Action				
ACHS-1 Cockpit Chronograph Right Knob - Push			Throttle - HOTAS Wa	Joystick - HOTAS Wa
ACHS-1 Cockpit Chronograph Right Knob - Rotate left				
ACHS-1 Cockpit Chronograph Right Knob - Rotate right				
ADF Failure Switch - ON/OFF				
ADF Switch - OFF				
ADF Switch - ON				
ADF Switch - ON/OFF				
ASP-3NMU Gunsight Brightness Knob Decrease				
ASP-3NMU Gunsight Brightness Knob, Increase				
ASP-3NMU Gunsight Color Filter, ON/OFF				
ASP-3NMU Gunsight Fixed Reticle Mask Lever				
ASP-3NMU Gunsight Glass Lower				
ASP-3NMU Gunsight Glass Raise				
ASP-3NMU Gunsight Mode, GYRO/FIXED				
ASP-3NMU Gunsight Target Distance, Decrease				JOY_BTN13
ASP-3NMU Gunsight Target Distance, Increase				JOY_BTN11
ASP-3NMU Gunsight Target Wingspan Adjustment Dial, Decrease				JOY_BTN14
ASP-3NMU Gunsight Target Wingspan Adjustment Dial, Increase				JOY_BTN12

Gunsight Target Range (x100 m)
(Controlled by Twist Grip on Throttle)

PART 9 – WEAPONS & ARMAMENT

GUNSIGHT – HOW TO DO A PROPER BOMB/ROCKET RUN

A proper tutorial for rocket and bomb delivery is listed in Eagle Dynamics' manual from pages 209 to 216. There is also one in the Steam forums here: <https://steamcommunity.com/sharedfiles/filedetails/?id=673640719>

Since the recommended shooting and bombing ranges exceed maximum distance (800 m) which can be entered into gunsight, fictitious target base should be entered for external base rangefinder to operate correctly. It is defined by the following equation:

$$B_f = B_a \times D_m / D_s$$

where:

- B_f – fictitious target base, m;
 - B_a – actual target size, m;
 - D_m – maximum distance, entered into gunsight - 800 m;
 - D_s – shooting (bombing) distance.
- D_s * - see Tables 1 and 2.

Example: a bomb delivery done at a **30** deg dive for an actual target size of **10** m.

The fictitious target size is the actual target size multiplied by the ratio of the maximum gunsight range (**800** m) over the required shooting distance/altitude in Table 1 (for bombs), which is **1500** m.

In other words: the “wingspan” (size) of the target you need to enter in your gunsight set at a max target range of **800** m is:

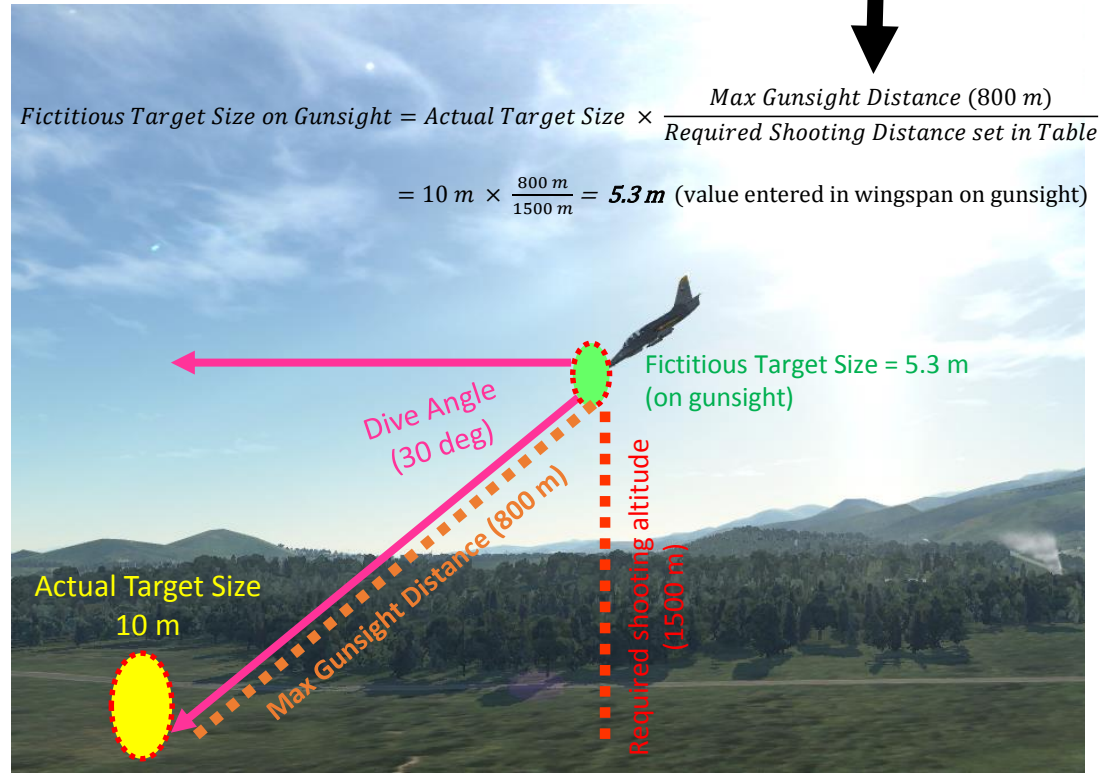

Bombs Delivery

Before the flight, make sure that the NETW, ARMS and SIGNAL CBs are enabled in rear cockpit.

Very important phase of dive bombing is arriving at point where turn and dive entry are performed. The accuracy of arriving at this point impacts on dive angle and release speed.

Bombing should be performed at diving angles of 20, 30 и 40 under conditions listed in table 1 below.

Table 1

No	Parameters	20°	30°	40°
1	Gunsight reflector deflection angle	13°	11°	10°
2	Dive entry altitude at ingress point	1200 m	1500 m	1800 m
3	Dive entry speed at ingress point	440 km/h	350 km/h	300 km/h
4	Release altitude	730 m.	800 m	1100 m
5	Release speed	570 km/h.	550 km/h.	560 km/h
6	RPM	97%	92%	MF%

Unguided Rockets Delivery

Before the flight make sure that the NETW, ARMS and SIGNAL CBs are enabled in rear cockpit.

Unguided rockets should be fired at dive angles of 20 and 30° under conditions listed in the Table 2.

Table 2.

No	Parameters	30°	20°
1	Gunsight reflector deflection angle	2,53°	2,30°
2	Dive entry altitude at ingress point	1200 m.	1200 m
3	Dive entry speed at ingress point	300 km/h	400 km/h
4	Shooting altitude	600 m.	500 m.
5	Speed at shooting moment	550 km/h	560 km/h
6	Shooting distance	1200 m	1460 m

PART 9 – WEAPONS & ARMAMENT

TUTORIAL – FLARES

1. Set EKSR-46 Signal Flare Dispenser Power switch to ON (UP)
2. Press desired flare button.



EKSR-46 Signal Flare Buttons

EKSR-46 Signal Flare Dispenser Power switch
UP=ON / DOWN = OFF

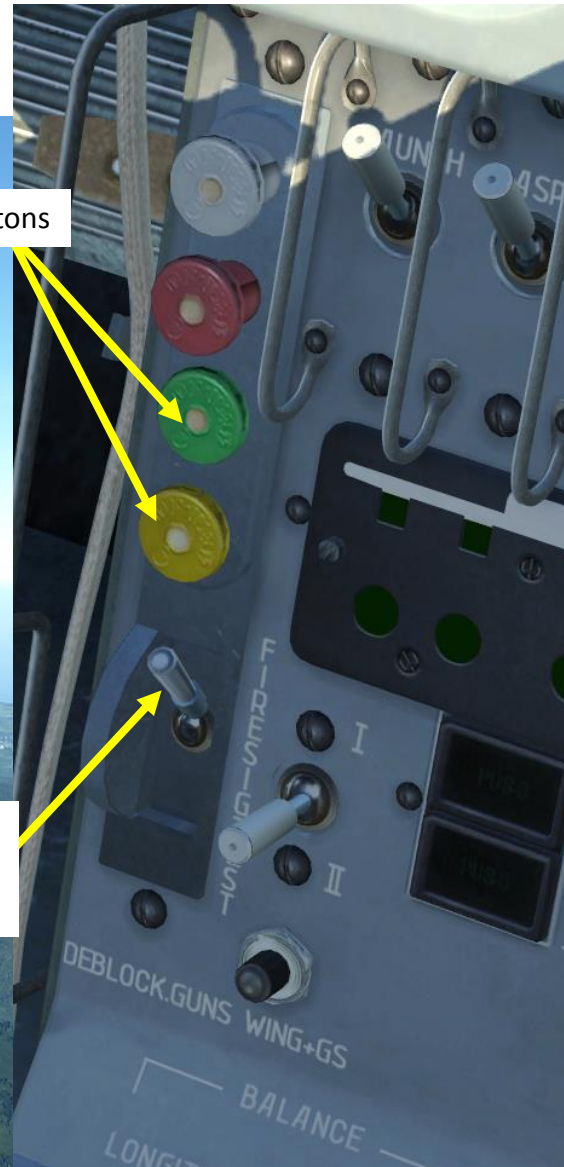

PART 9 – WEAPONS & ARMAMENT

TUTORIAL – JETTISON ORDNANCE

- To jettison inner pylons, use switch A (UP position).
- To jettison outer pylons, use switch B (UP position).
- As a safety measure, use the LIVE/BLANK switch to disarm your bombs if you jettison them (DOWN position). Use switch C (DOWN).
- To launch your missiles in an emergency, use switch D.

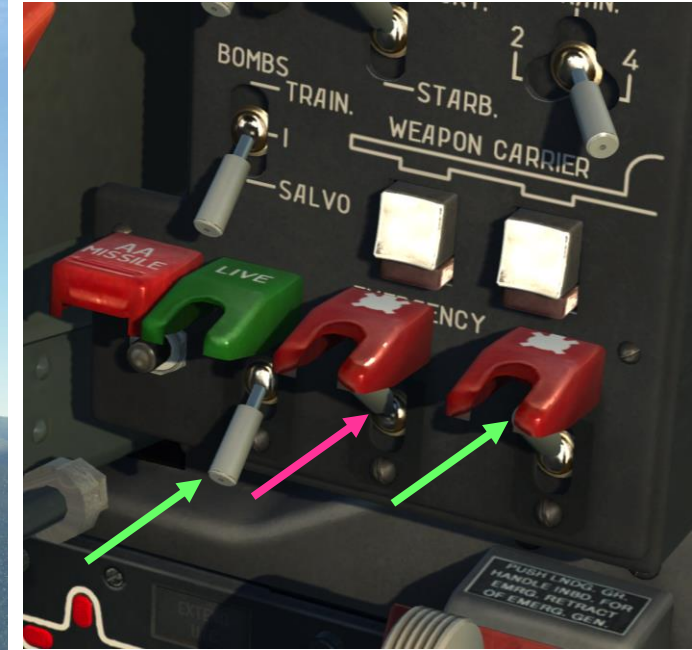
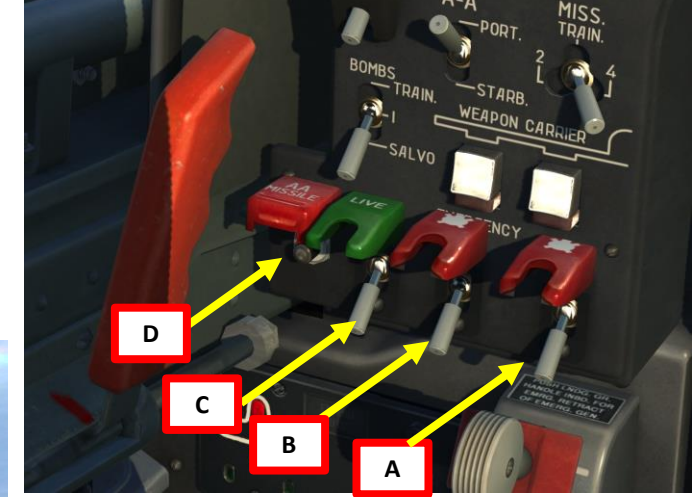
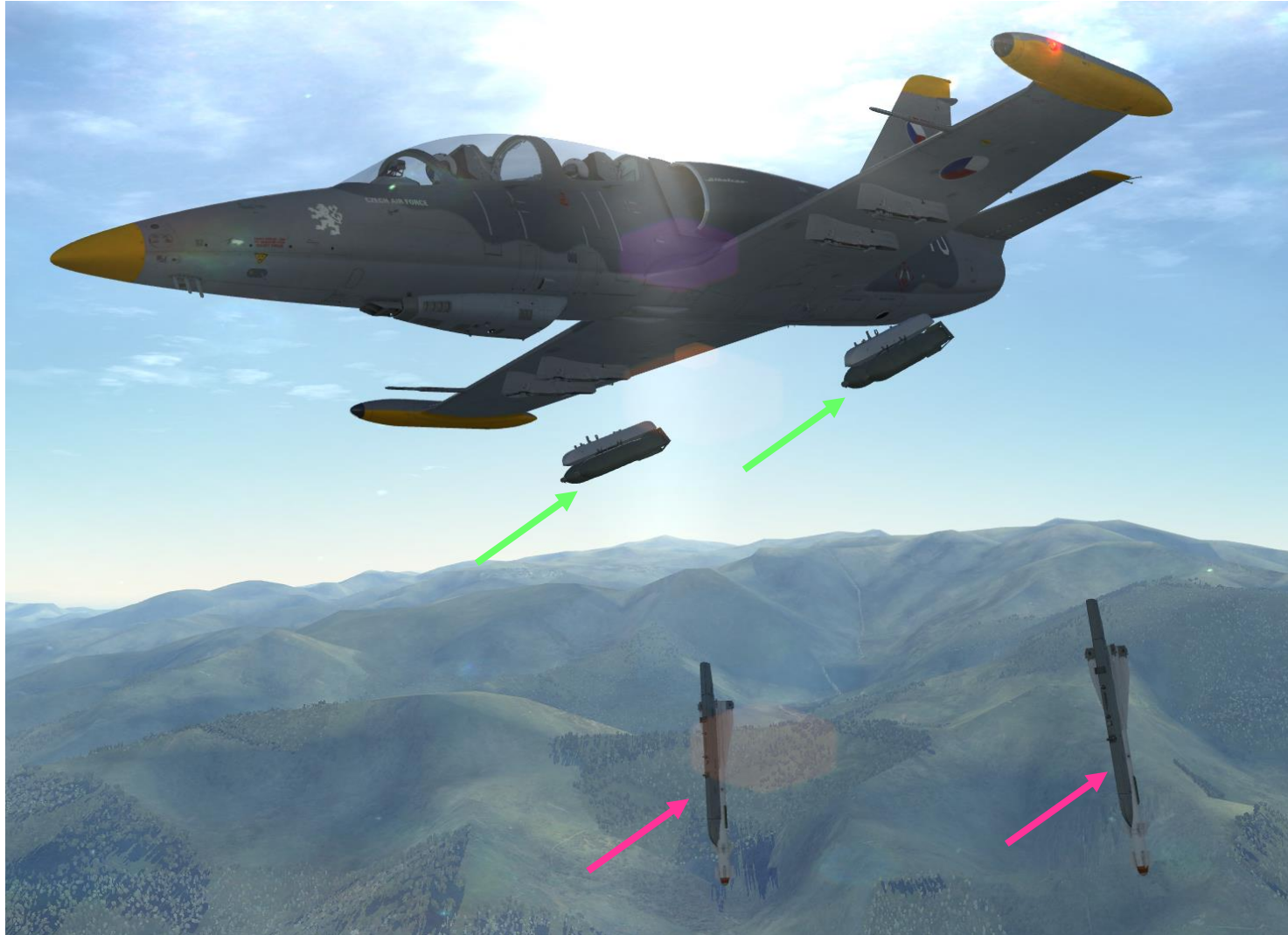

PART 10 – RADIO TUTORIAL

TO USE R-832M AM RADIO:

1. In the mission editor, you can manually set each preset channel to a certain frequency. These frequencies should all be given to you in the mission briefing.
2. Turn ON (FWD) RDO ACB switch.
3. Turn SQUELCH switch ON (FWD).
4. Turn RADIO CONTROL switch ON (FWD).
5. Select desired radio channel using the selector switch.
6. Use microphone switch (on throttle) to communicate on set frequency to transmit.

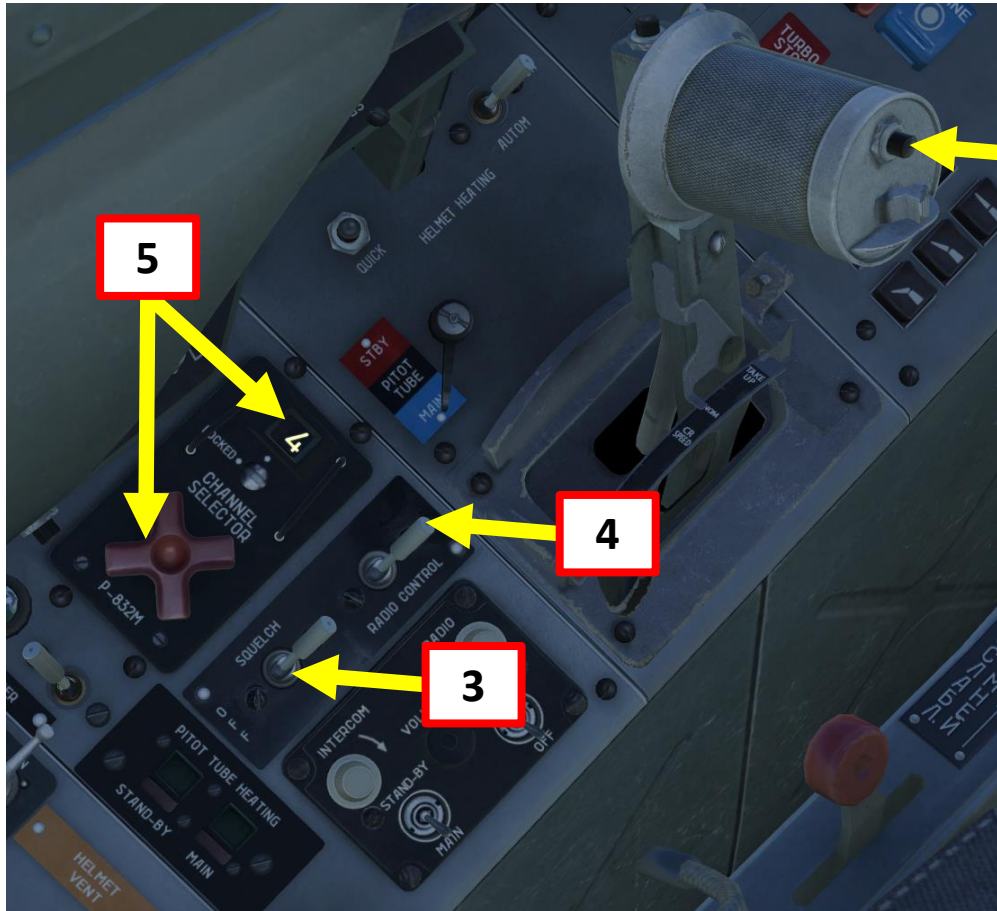

R-832M AM Radio Frequency Range
118 MHz to 390 MHz

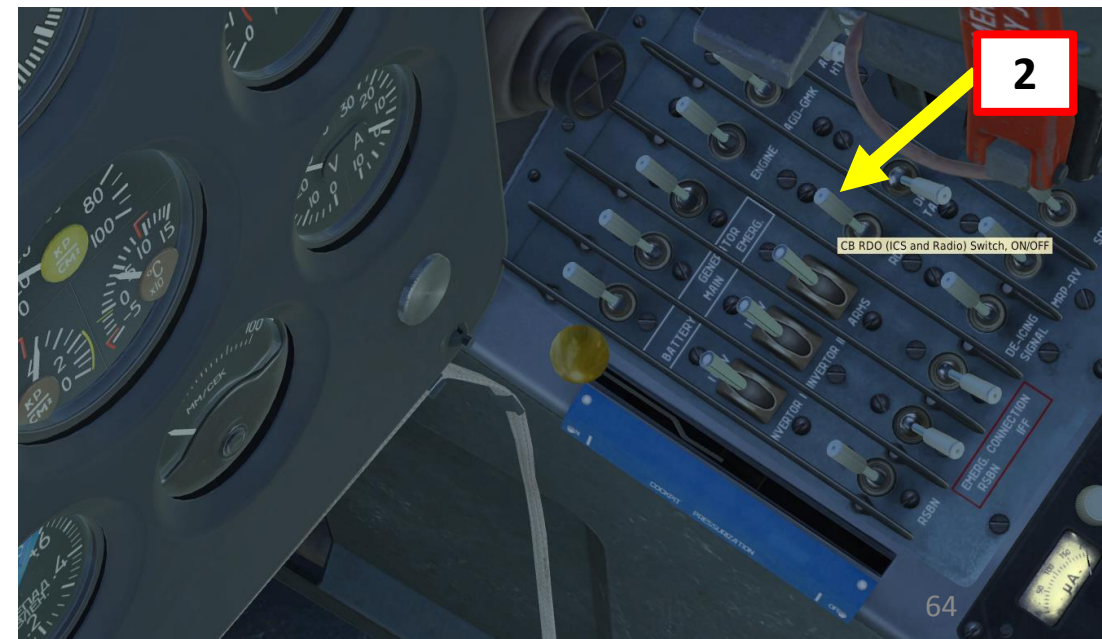
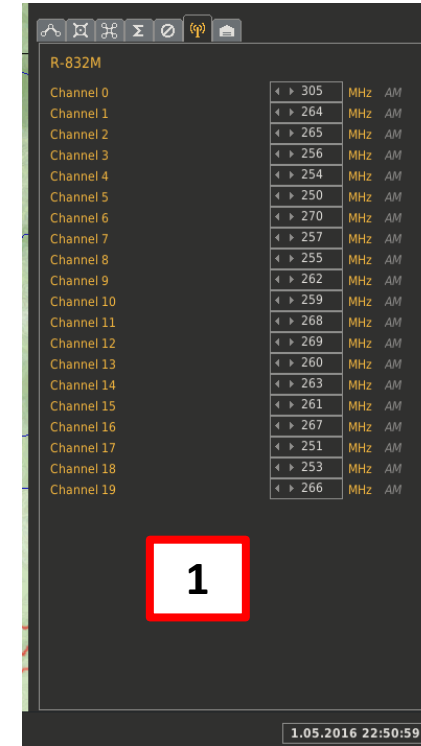

R-832M AM RADIO FREQUENCIES – AIRFIELDS

LOCATION	AM FREQUENCY (Mhz)
Anapa	250.00
Batumi	260.00
Beslan	270.0
Gelendzhik	255.00
Gudauta	259.00
Kobuleti	262.00
Kutaisi	263.00
Krasnodar Center	251.00
Krasnodar Pashkovsky	257.00
Krymsk	253.00
Maykop	254.00
Mineral'nye Vody	264.00
Mozdok	266.00
Nalchik	265.00
Novorossiysk	252.00
Senaki	261.00
Sochi	256.00
Soganlug	268.00
Sukhumi	258.00
Tblisi	267.00
Vaziani	269.00

UNDERSTANDING NDB, RSBN, PRMG

Navigation is an extensive subject. You can check chapter 15 of FAA manual for more details on navigation.

LINK: http://www.faa.gov/regulations_policies/handbooks_manuals/aviation/pilot_handbook/media/PHAK%20-%20Chapter%2015.pdf

- “NDB” is what we call a non-directional beacon. It transmits radio waves on a certain frequency on long distances. These waves are read by an ADF (automatic direction finder), which is the RKL-41 ADF system on the L-39. NDBs are typically used for radio navigation.
- “VOR” is what we call a VHF Omnidirectional Range system. It transmits radio waves on a certain frequency. These waves are read by a VOR receiver. VOR systems, just like NDBs, can be used for radio navigation.
- NDB and VOR are used just like lighthouses were used to guide ships. This way, air corridors and airways are created to help control an increasingly crowded sky.
- ILS (Instrument Landing System) allows an aircraft find their way to an airstrip (provided it is equipped with a VOR or NDB) despite bad visibility conditions.
- TACAN is a Tactical Air Navigation System used by the military. TACAN beacons can be placed on ground stations, airfields or even aircraft themselves like tankers. A TACAN beacon will provide you line-of-sight bearing and range to the selected TACAN station.
- **RKL-41 ADF** (automatic direction finder) system on the L-39 can help you track NDB stations.
- The **RSBN** (Short Range Radio Navigation System) is the russian equivalent of a TACAN system (and is used similarly to a VOR as well).
- NDBs have a max range of approximately 120 km.
- RSBNs have a max range of approximately 300-400 km.
- ARC and RSBN stations are complementary: you can use both of them to help you navigate. Simply put, you can use many different types of “lighthouses” (beacons and stations) to navigate through the sky.
- The **PRMG** is the russian equivalent of a ILS (Instrument Landing System). It uses RSBN beacons to guide you to the airstrip when you need to land in bad weather or low visibility conditions like night missions.

NDB RANGE IN FUNCTION OF MINIMUM ALTITUDE

Distance from station (km)	20	40	60	80	100	120
Minimum altitude (m)	350	700	1050	1400	1750	2100

PART 11 – NAVIGATION & ILS LANDING

NDB, RSBN AND PRMG STATIONS – HOW TO FIND THEM?

FIND THEM?

Lino_Germany created a **wonderful** HD map containing all RSBN and PRMG stations scattered throughout the map. Use this to know the NDB, RSBN or PRMG stations you need to use.

LINK: <https://drive.google.com/file/d/0B-uSpZROuEd3LVDRDS3hyaFlkUEk/view?usp=sharing>

Lino_Germany's
DCS BEACON MAP
 Version 1.46

PRMG/ILS STATION
 NDB
 RSBN STATION (NAV)

NOTE: ONLY A FEW AIRPORTS ARE EQUIPPED WITH ADEQUATE RSBN BEACONS USEABLE BY THE L-39. RSBN FREQUENCIES IN THE TABLE BELOW ARE FOR RSBN NAVIGATION BEACONS AND FOR PRMG BEACONS.

RSBN NAVIGATION FREQ.	PRMG FREQ.	AIRPORT / RUNWAY HDG	RSBN MORSE CODE
N/A	N/A	ANAPA-VITYAZEVO / 42	-... ..
N/A	N/A	BATUMI / 126	
N/A	N/A	BESLAN / 94	
N/A	N/A	GELENDZIK	-.-.
N/A	N/A	GUDAUTA-BOMBORA	-.-. ... -.-
N/A	N/A	KOBULETI / 70	-.-. -.- ...
40	38	KRASNODAR-CENTER / 87	-.-. ... -.-
N/A	N/A	KRASNODAR-PASHKOVSKIY / 47	-.-. -.- ...
28	26	KRYMSK / 40	-.-. -.- ...
N/A	N/A	KUTAISI-KOPITNARI / 74	-.-. -.- ..
34	36	MAYKOP-KHANSKAYA / 39	-.-. -.-. -.-
N/A	N/A	MINERANYE VODY / 115	-.-. -.-. -.-
20	22	MOZDOK / 83	-.-. -.-. -.-.
N/A	N/A	NALCHIK / 56	-.-. -.-. -.-
N/A	N/A	NOVOROSSIYSK	
N/A	N/A	SENAKI-KOLKHI / 95	... -.-.-
N/A	N/A	SOCHI-ADLER / 62	-.-. -.-. -.-
N/A	N/A	SUKHUMI-BABUSHARA	
N/A	N/A	TBILISI-LOCHINI / 128	-.-. -.-. -.-
N/A	N/A	TBILISI-VAZIANI / 135	-.-. -.-. -.-

PART 11 – NAVIGATION & ILS LANDING

NAVIGATION EXAMPLE (NDB ADF)

Note: ARC stations can also be used during landing, so the example could potentially be combined with a PRMG approach as well.

In this example, we will fly over the outer and inner NDB beacons placed in the vicinity of Kobuleti using the RKL-41 ADF (Automatic Direction Finder). We will do the following:

- Fly towards **Kobuleti** and gain an altitude of at least 2,500 m.
- Use the RKL-41 ADF system to navigate to **Kobuleti's Outer NDB Beacon, ADF frequency 870** (obtained through Lino Germany's map).
- Use the RKL-41 ADF system to navigate to **Kobuleti's Inner NDB Beacon, ADF frequency 490** (obtained through Lino Germany's map).

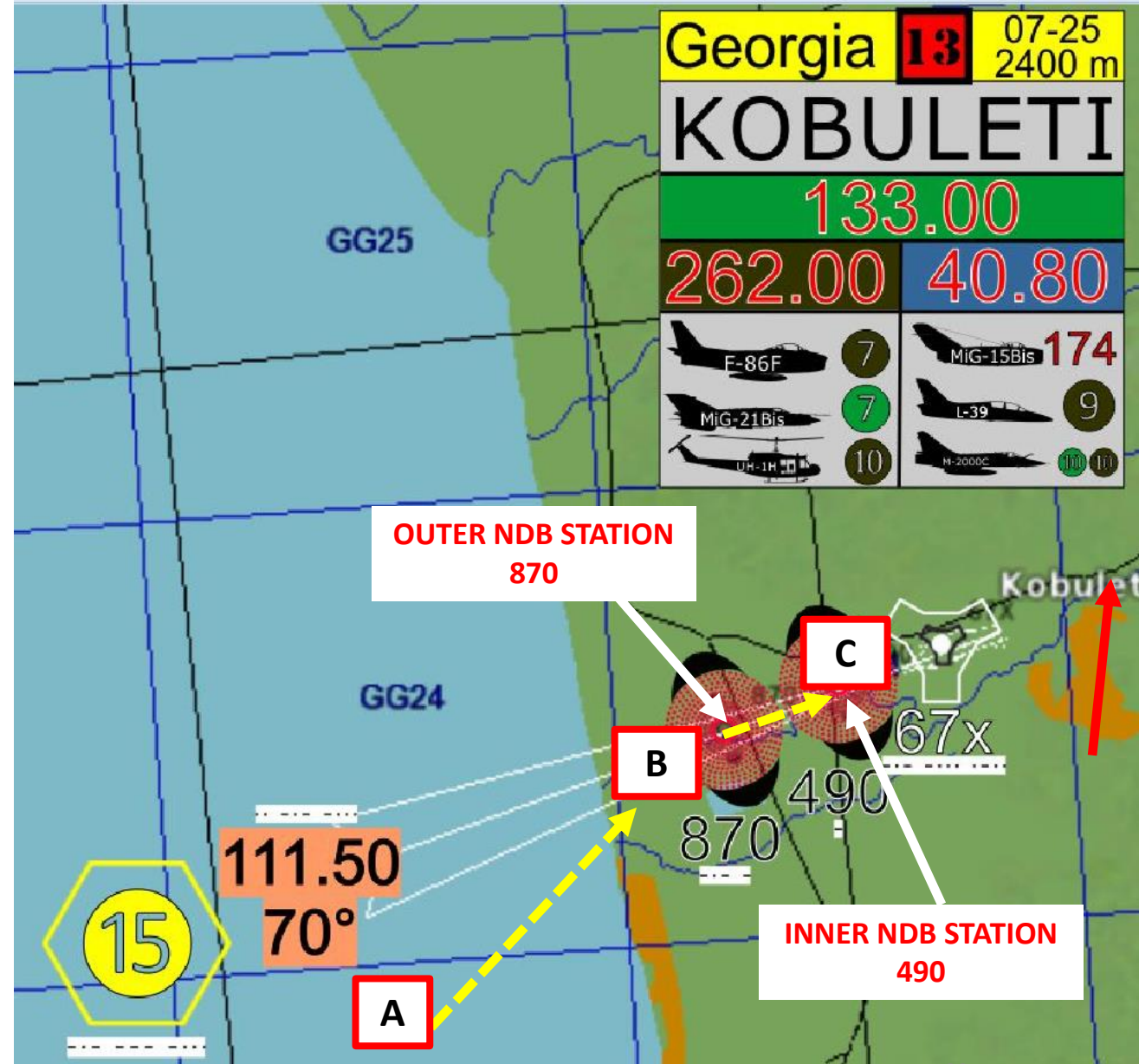

PART 11 – NAVIGATION & ILS LANDING

NAVIGATION EXAMPLE (NDB ADF)

- 1) Set ADF switch to ADF
- 2) Tune volume knob as required
- 3) Set your frequencies for a) the Outer NDB (490) and for b) the Inner NDB (870).
- 4) Set RLK-41 ADF mode to either Automatic or Manual (Automatic will automatically switch from your Outer to your Inner NDB when you reach the Outer marker)
- 5) Set to TLF (Telephony) if you want to hear the audio tone of the beacon. Set to TLG (Telegraph) if you prefer to see a signal intensity indication instead.
- 6) Set RLK-41 ADF CONTROL switch to the left if you are in the front cockpit or to the right if you are in the rear cockpit.
- 7) Set your OUTER/INNER NDB selector to “OUTER” to track the Outer NDB.

Check out XXJohnXX's excellent tutorial on NDB navigation:
<https://www.youtube.com/watch?v=cOz2Ue6U680>

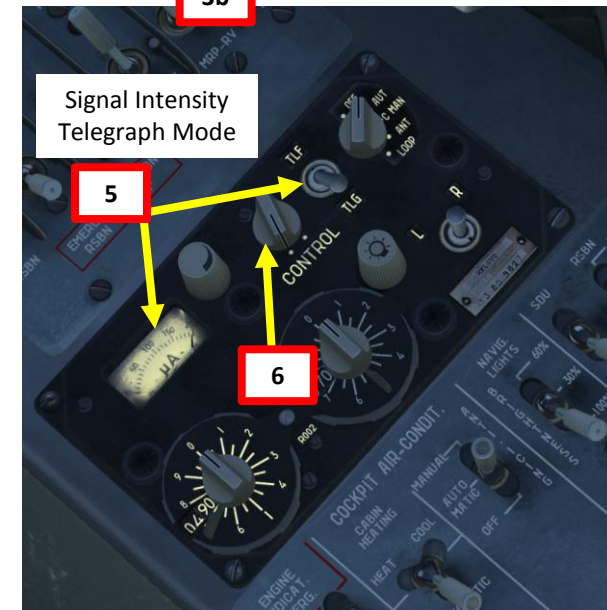
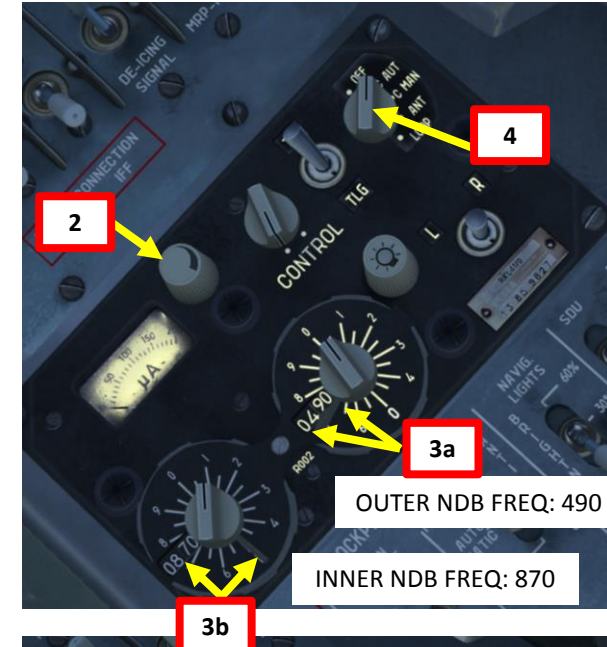
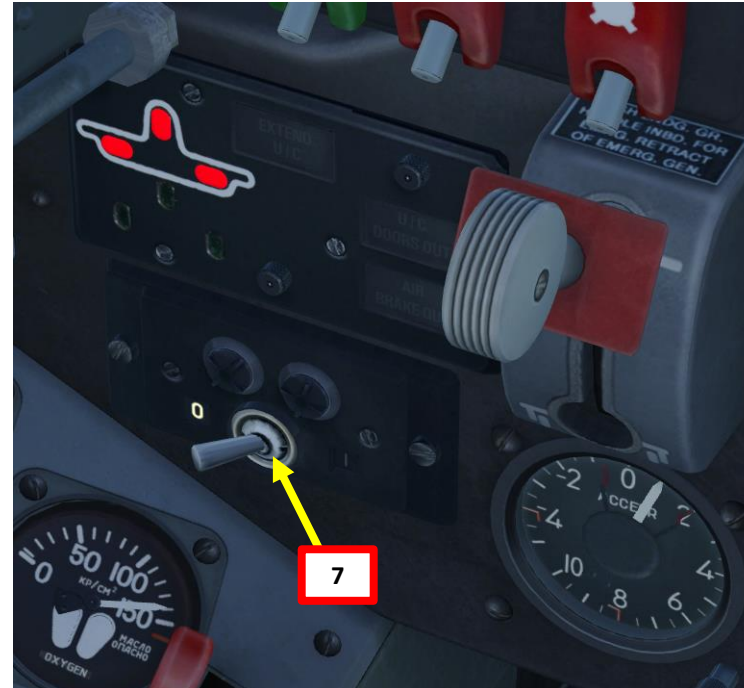

PART 11 – NAVIGATION & ILS LANDING

NAVIGATION EXAMPLE (NDB ADF)

- 8) Consult ADF gauge and follow the needle tracking the NDB.
- 9) You will be heading towards the NDB when your ADF needle will point towards “0” (vertical).
- 10) You will fly over the Outer NDB when the “MARKER” caution will illuminate.
- 11) If ADF is set to **AUTO** mode (step 4), INNER NDB will be selected automatically **ONLY IF YOU ARE ON COURSE AND IF YOUR LANDING GEAR IS DOWN.** If ADF is set to MANUAL mode, set the OUTER/INNER NDB selector to “INNER”.
- 12) Your ADF gauge will now be tracking the INNER NDB.

Check out XXJohnXX's excellent tutorial on NDB navigation:
<https://www.youtube.com/watch?v=cOz2Ue6U680>

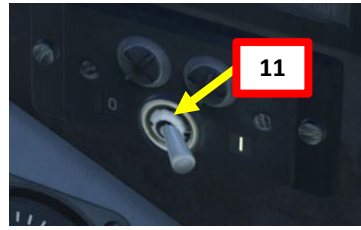
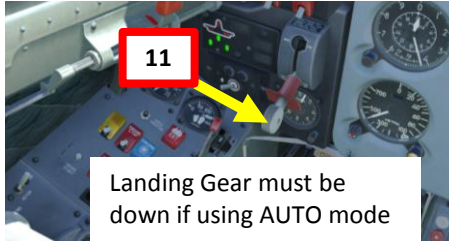

Landing Gear must be down if using AUTO mode

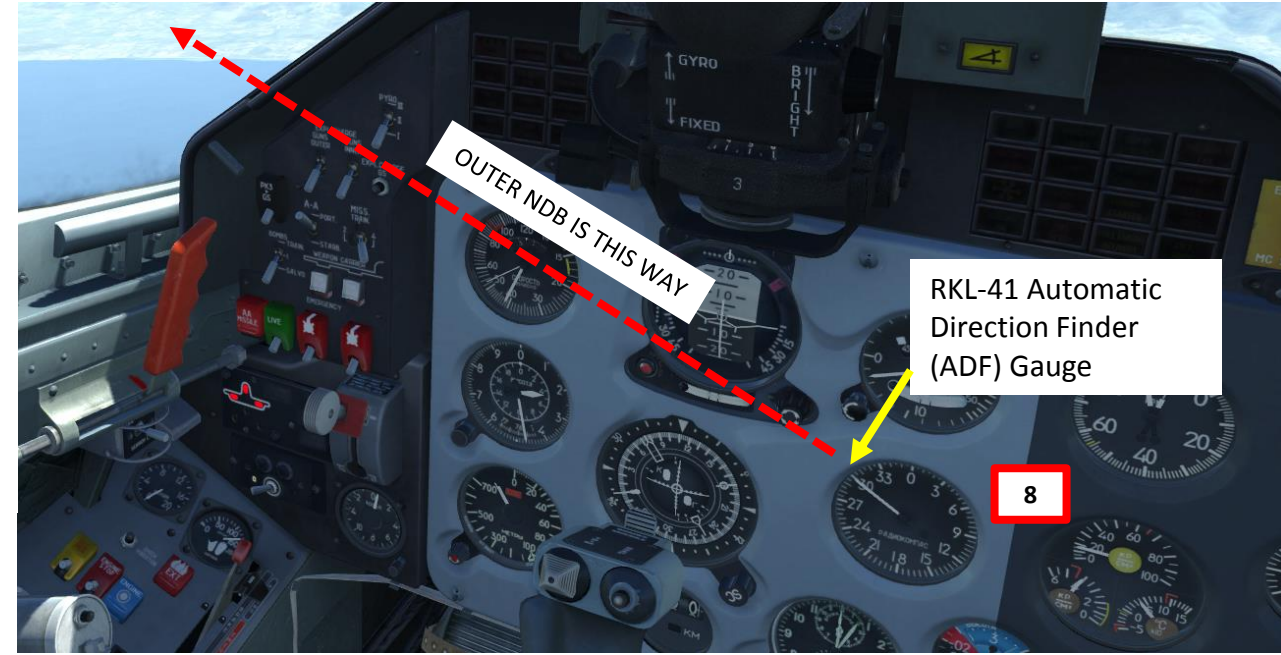

PART 11 – NAVIGATION & ILS LANDING

RSBN STATIONS (VOR)

- RSBN VOR stations are generally set next to airstrips to guide air traffic towards airfields, unlike NDBs which can be placed anywhere... sort of. In simple terms, you could compare NDBs to waypoints on an “air highway” and VOR stations to the exits of this “air highway”.
- You are guided to RSBN stations by both your **NPP** (HSI: Horizontal Situation Indicator, or radio compass) and your **KPP**, which works like an ADI (Attitude Director Indicator) augmented with an ILS (Instrument Landing System).
- RSBN signals give you a direction AND a distance.
- RSBN signals are used for PRMG (ILS) precision landings in bad weather or low visibility conditions.
- To pick up RSBN signals, make sure you are flying at an altitude of at least 2,500 m.

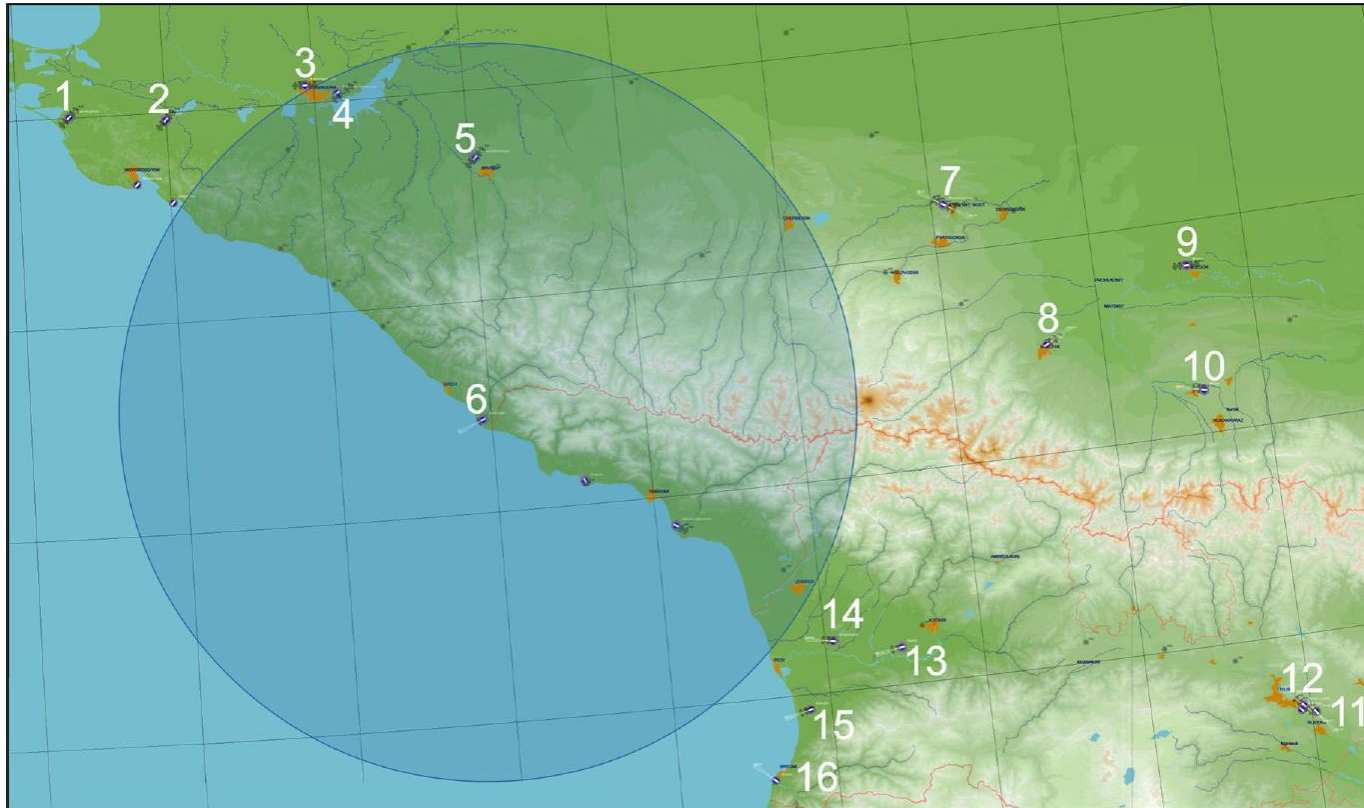

PART 11 – NAVIGATION & ILS LANDING

NAVIGATION EXAMPLE (RSBN + PRMG LANDING)

In this example, we will plan a flight from Anapa to Krymsk, and then proceed to Krasnodar-Center for an ILS landing using the PRMG and RSBN beacons. We will do the following:

- Takeoff from **Anapa** and gain an altitude of at least 2,500 m.
- Use the RSBN system to navigate to **Krymsk**, RSBN channel 28 (obtained through RSBN frequency table on the previous page).
- Use the RSBN system to navigate to **Krasnodar-Center** using RSBN channel 40 and perform a PRMG precision approach to land at Krasnodar-Center airfield, **PRMG channel 38** (obtained through the RSBN and PRMG frequency tables on the previous page).

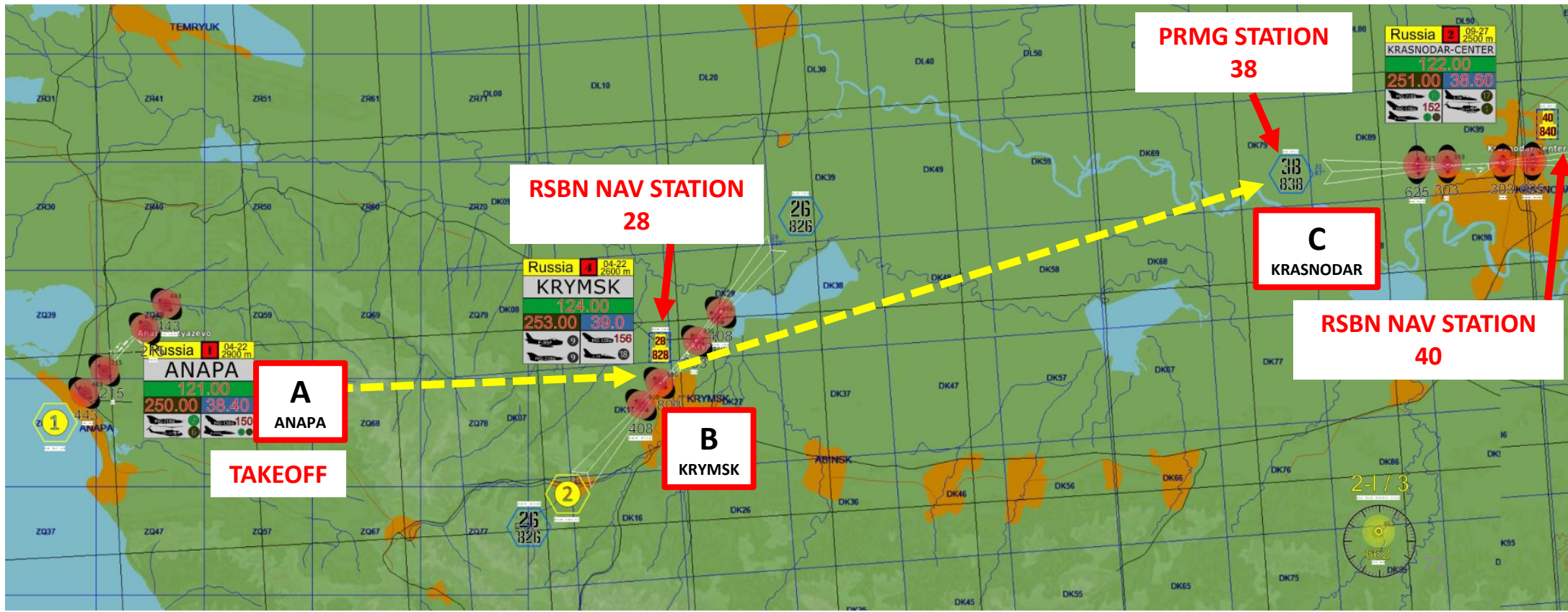
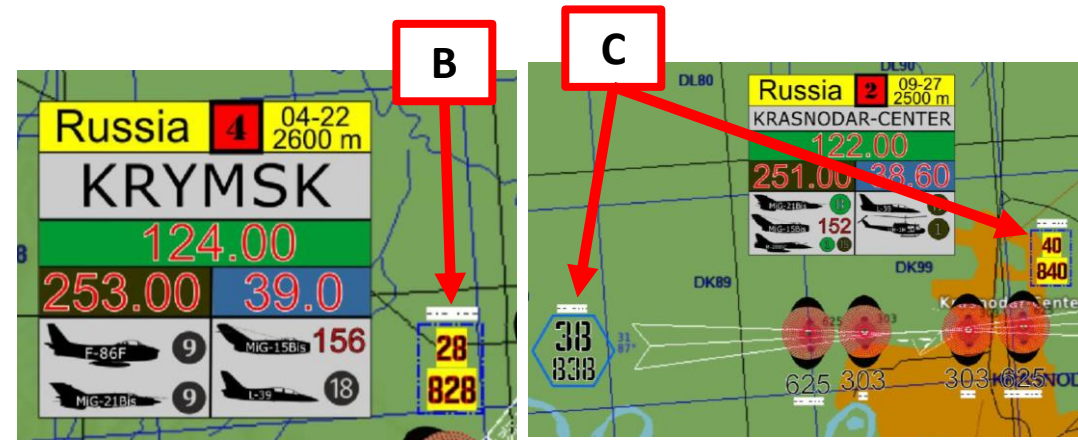

PART 11 – NAVIGATION & ILS LANDING

NAVIGATION EXAMPLE – RSBN + PRMG

Check out XXJohnXX's excellent tutorial on RSBN navigation:
<https://www.youtube.com/watch?v=qUVslmJ57Vw>

1. Takeoff from Anapa
2. Set RSBN switch to ON (FWD)
3. Set RSBN Mode switch to "NAVIG".
4. Set RSBN NAVIGATION channel to 28 (Krymsk RSBN). When signal is picked up, AZIMUTH/DISTANCE lights will illuminate.
5. Consult NPP (HSI) and line up RSBN needle with reference index (white triangle).
6. When reaching NDB 28, your HSI needle will progressively do a 180 as you fly past the beacon. This is our cue to change RSBN frequency for the next RSBN navigation beacon at Krasnodar-Center (Channel 40 for NAV).



RSBN needle does a 180-degree turn as we fly past the first RSBN beacon

We flew 5 km past the first RSBN beacon

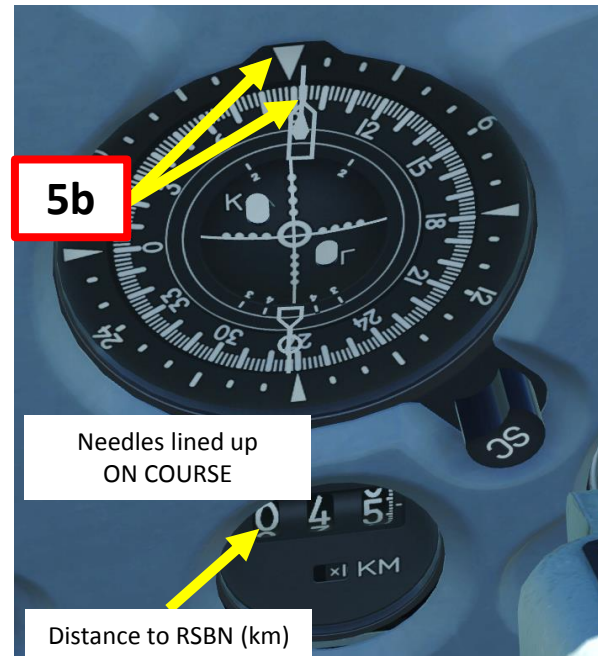
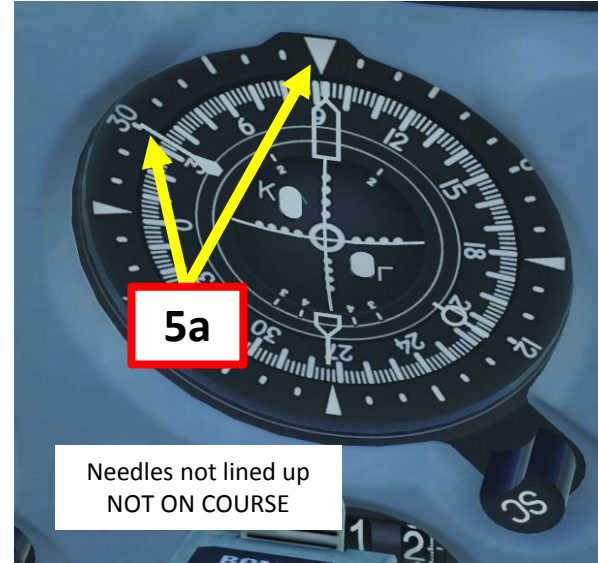

Distance to RSBN (km)

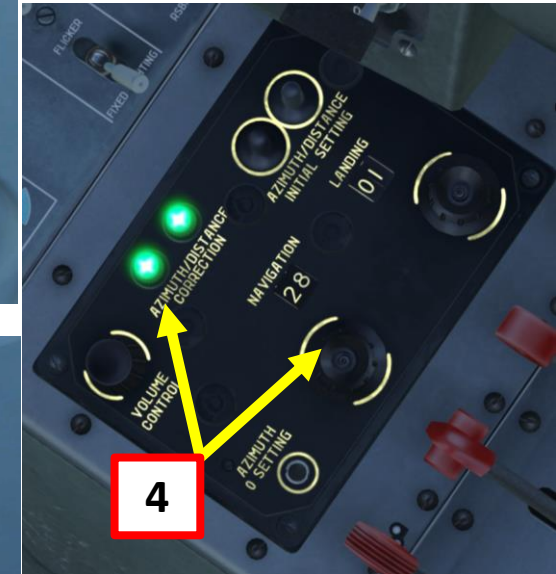
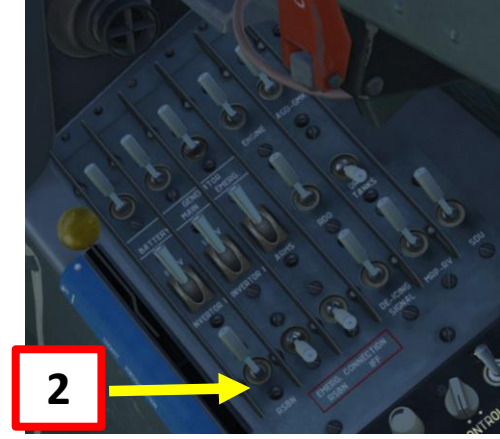

PART 11 – NAVIGATION & ILS LANDING

NAVIGATION EXAMPLE – RSBN + PRMG

7. Set RSBN NAVIGATION channel to 40 (Krasnodar-Center RSBN). When signal is picked up, AZIMUTH/DISTANCE lights will illuminate.
8. As shown in step 4), consult NPP (HSI) and line up RSBN needle with reference index (white triangle) once again.
9. We will now need to take the 087 Radial to reach the Krasnodar-Center runway (basically, we will be flying through the “air corridor 087” as if we were taking a car on a highway).
10. Rotate 3K knob to set a course to Krasnodar’s runway radial (087). Fly until your heading’s needle and the radial’s course needle are lined up. Once this is done, you will be “surfing” the radial.

Check out XXJohnXX’s excellent tutorial on RSBN navigation: <https://www.youtube.com/watch?v=qUVslmJ57Vw>

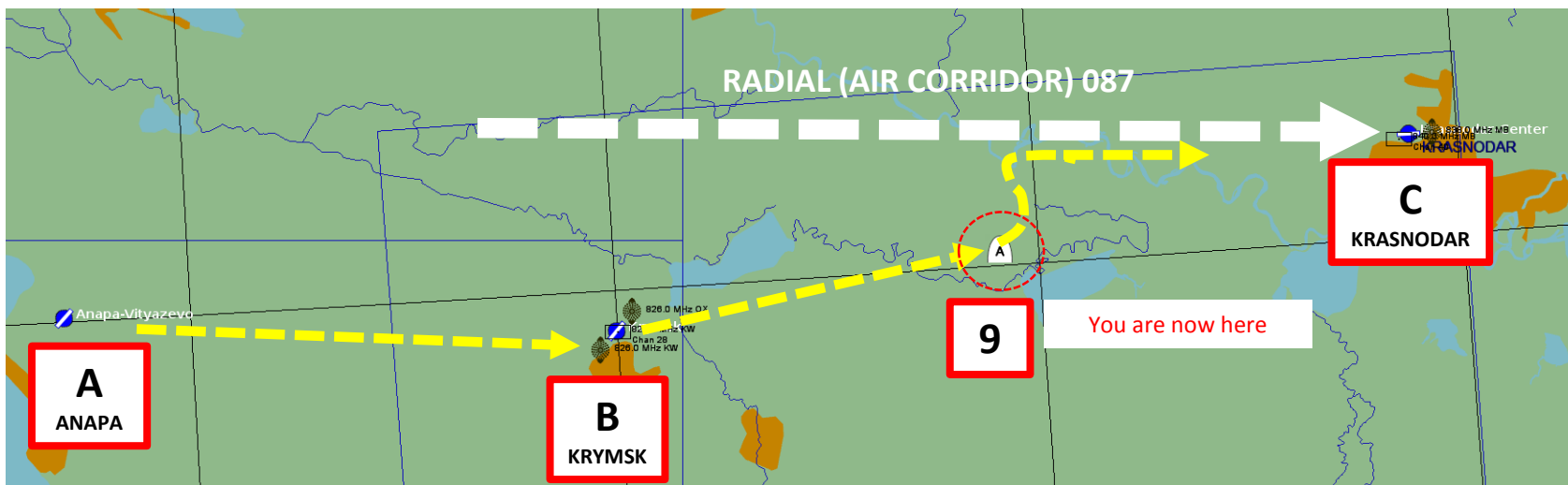
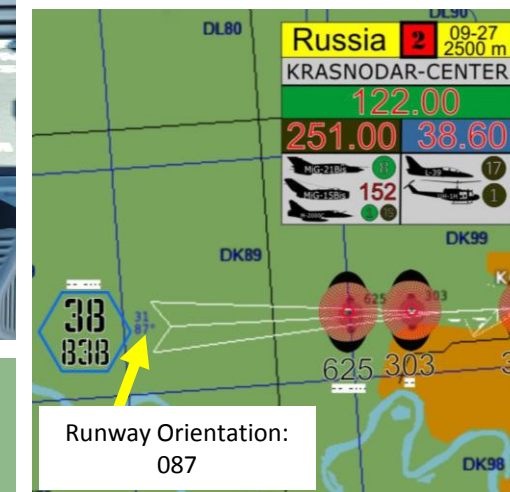
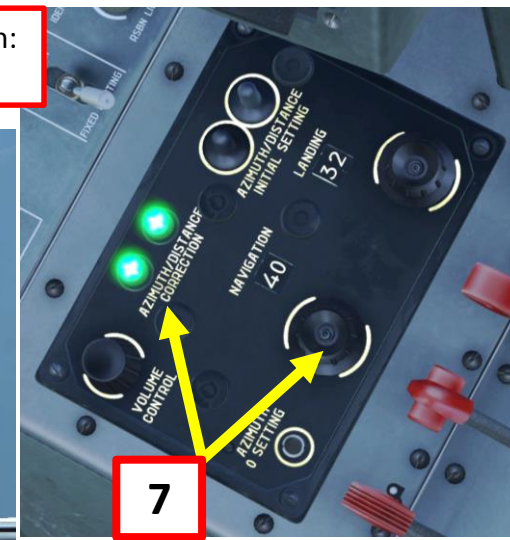
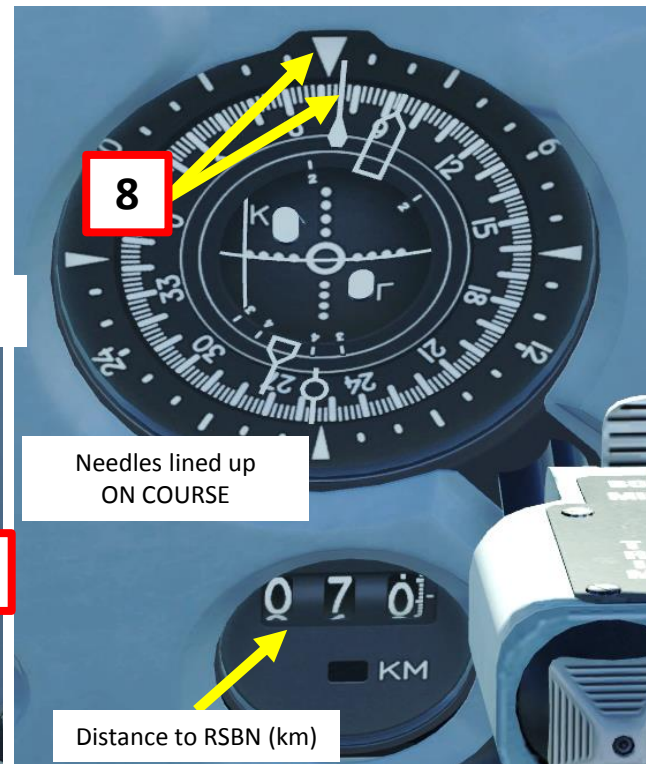
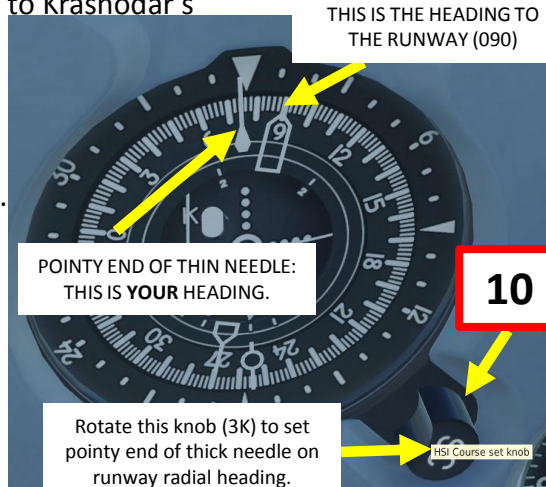

PART 11 – NAVIGATION & ILS LANDING

NAVIGATION EXAMPLE – RSBN + PRMG

11. Now that we are surfing the radial, wait until you are 20 km away from Krasnodar's beacon and 600 m high to turn on the PRMG system.
12. Set PRMG channel to 38 (Krasnodar-Center PRMG/ILS station).
13. Set both SDU Flight Director switches to ON (FWD).
14. Set RSBN Mode switch to "LANDING"
15. "T" and "K" flags should disappear if PRMG signal is received properly on ADI.
16. Line up vertical bar and horizontal bars on ADI to capture good landing attitude and good glideslope and heading.

Check out XXJohnXX's excellent tutorial on RSBN navigation:
<https://www.youtube.com/watch?v=qUVslmJ57Vw>

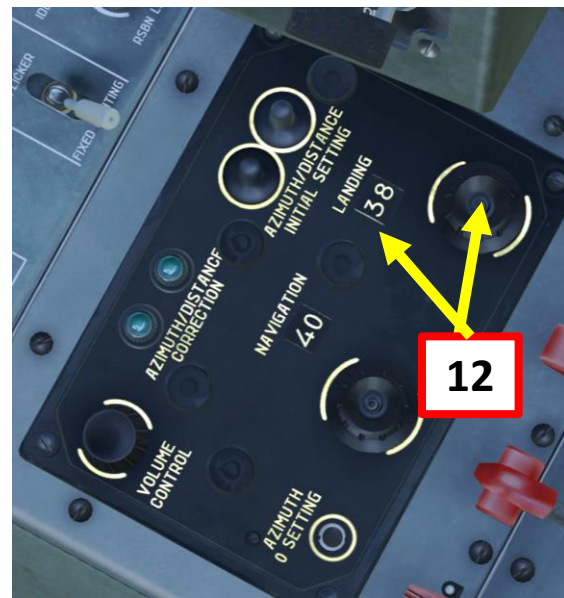
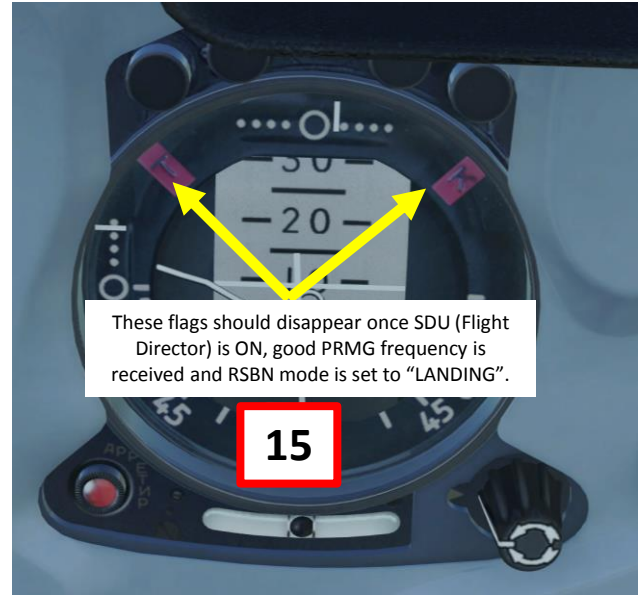

Line these up to capture good glide slope

Line these up to follow good heading

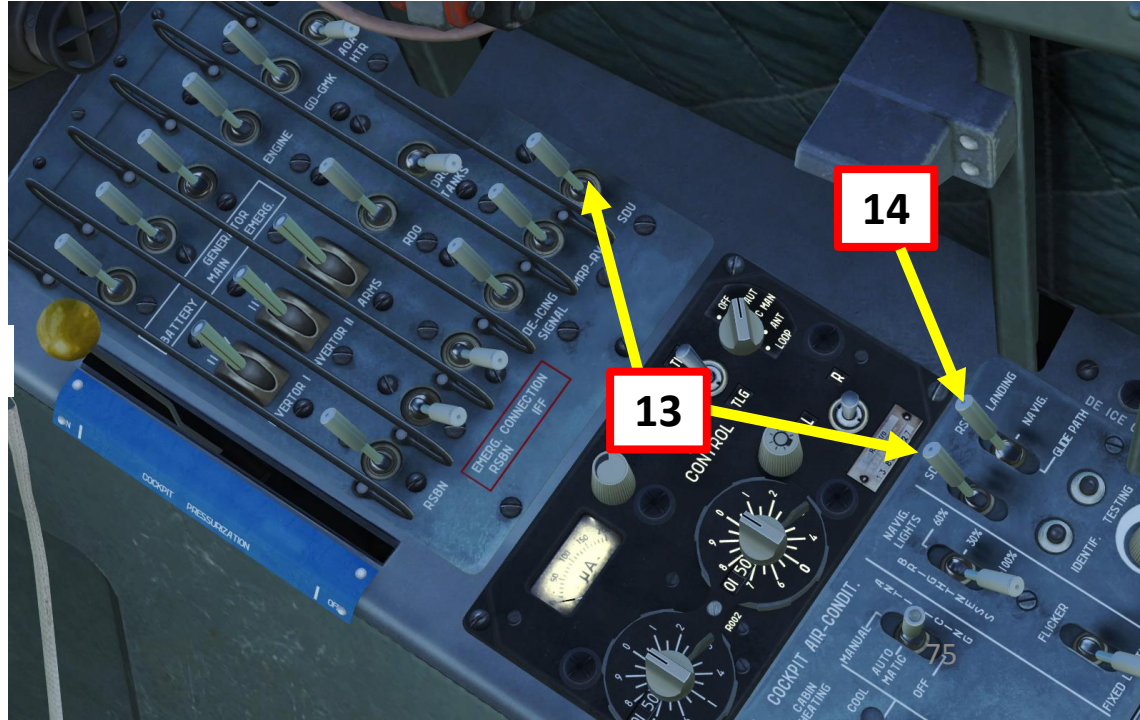
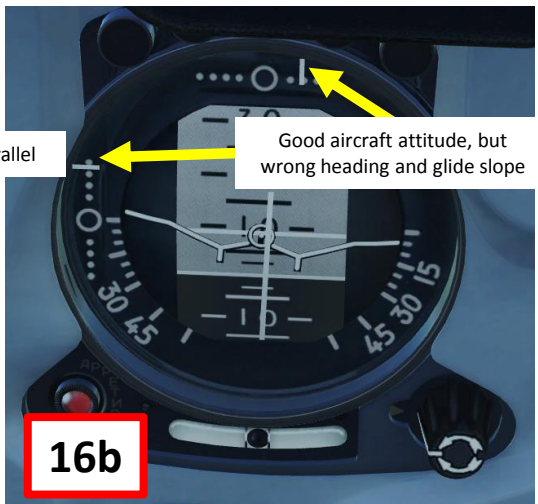
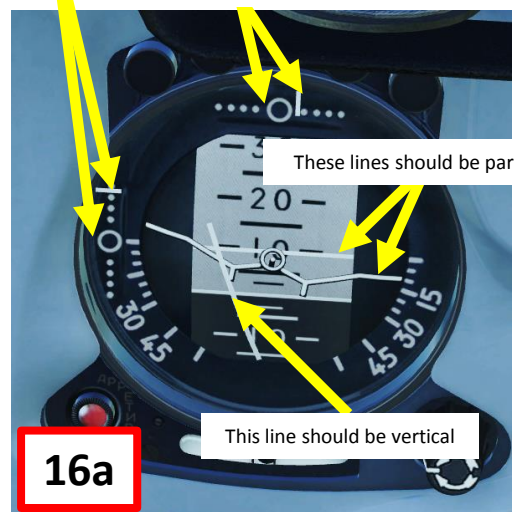

PART 11 – NAVIGATION & ILS LANDING

NAVIGATION EXAMPLE – RSBN + PRMG

- Once you are lined up with the PRMG lines on the ADI, maintain airspeed, glideslope and attitude and perform a normal landing.
- Deploy flaps at LANDING position when reaching 250 m and deploy landing gear. Maintain 230 km/h on final.
- Touchdown at 180 km/h. Flare gently.



18

NOTE: An important distinction needs to be made between RSBN and PRMG stations: RSBN stations are used by civilian air traffic while PRMG stations are generally used by the Russian military only. Both systems are independent from one another. Furthermore, PRMG systems are only available for use if the Airfield Tower allows you to use it. As in real life, PRMG systems are set for certain runways only, not for every single one. Tower Controllers in DCS will allow you to use certain runways in certain conditions only (bad weather and great winds for instance). As an example, PRMG systems will not be available if you have no headwinds. However, PRMG station will be available if you have a strong headwind (5+ m/s) or low visibility, which will trigger the runway 090 in Krasnodar-Center to become the “active” (available) runway. If a PRMG beacon cannot be detected (even if you entered the right PRMG channel) in one of your missions, maybe the runway is not “active” since weather conditions do not require you to use a PRMG system.

Check out XXJohnXX's excellent tutorial on RSBN navigation:
<https://www.youtube.com/watch?v=qUVslmJ57Vw>

17



Runway 087

Good heading

Good attitude

Good glideslope

19



PART 12 -- AEROBATIC FLYING

Aerobatic flying deserves a whole book written on it. Formation flying and airshow routines can be some of the toughest things to do in DCS. Many virtual aerobatic teams practice hundreds of hours in order to master their aircraft inside out. The L-39 highlights the fact that the flight sim community is diverse in the sense that everyone has different needs and flies for different reasons. Some folks are just not interested in combat. Although, that doesn't mean that they don't like to fly! Mastering the art of formation flying can be just as challenging as hunting down Flankers in the skies of Georgia.

This superb video of the mighty Breitling Jet Team says it all:

<https://www.youtube.com/watch?v=M3zBE3Co2sY>

The following screenshots were flown and taken by the "Virtual Breitling Jet Team".

Consult their facebook page to see them in glorious HD:

<https://www.facebook.com/Virtual-Breitling-Jet-Team-685268548224607/>



PART 12 -- AEROBATIC FLYING

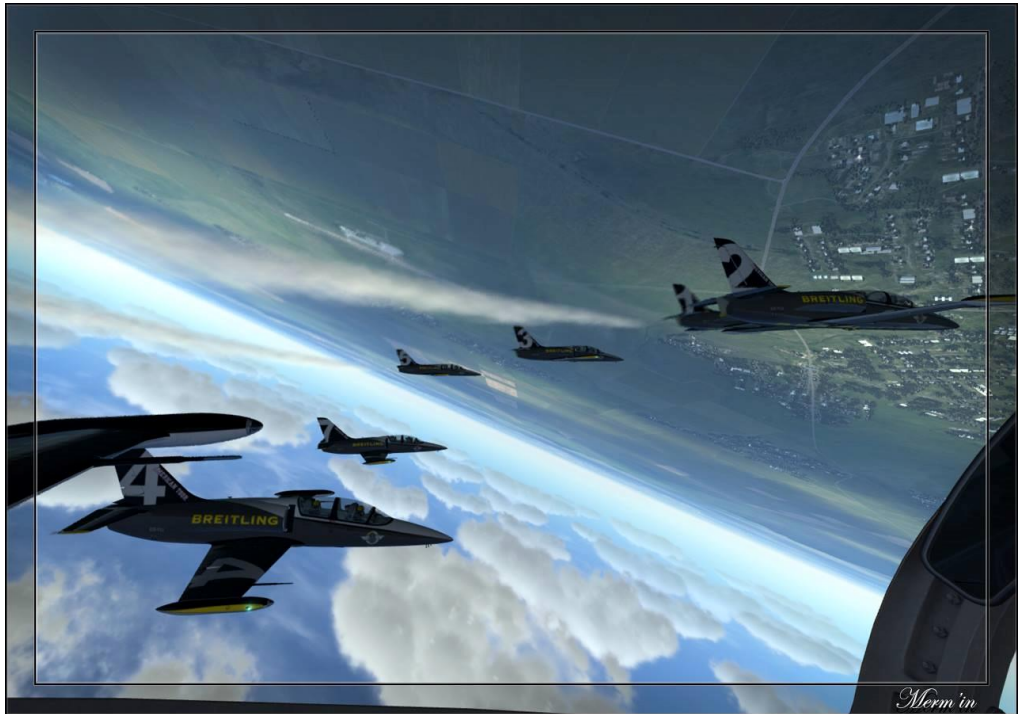

PART 12 -- AEROBATIC FLYING



Worm'in



Worm'in



Worm'in



Worm'in

PART 13 – TRAINING AND FAILURE SIMULATION

THE IMPORTANCE OF INSTRUMENTS

- **Pressure sensors** reading the air pressure outside your aircraft are what allow you to know at what **airspeed** you are flying, at what **altitude** you are and your **vertical velocity**. These indications are given on the , altimeter and variometer.
- A Pitot-Static system consists of a **Pitot Tube** (reads total pressure) and a **Static Port** (reads static pressure).
- If you have a static port or a pitot tube malfunction, your total pressure and static pressure sensor readings will be affected.
- A wrong total pressure or static pressure reading will result in your gauges displaying wrong airspeed, altimeter and vertical velocity indications.
- There is a **relationship between airspeed, altimeter, the vertical velocity and a pitot-static system.**
- The ALTIMETER needs a static pressure sensor (static port)
- The VARIOMETER needs a static pressure sensor (static port)
- The AIRSPEED indicator needs a dynamic pressure reading (pitot tube + static port)

1. Airspeed can be found with air pressure sensors placed on the aircraft.
2. There are 2 types of pressure: static and dynamic.
3. Static pressure is the ambient air pressure
4. Dynamic pressure is based on the pressure differential between you and a moving fluid (like wind!)
5. Total pressure = dynamic pressure + static pressure
6. Dynamic pressure = total pressure - static pressure
7. Dynamic pressure is a function of air density (which varies with altitude) and airspeed.
8. $Dynamic\ Pressure = \frac{1}{2} * (Air\ Density) * (Airspeed)^2$
9. From that equation, we know that airspeed is found from dynamic pressure.
10. Therefore, if we have sensors for the total pressure (obtained from pitot tube, which is like a dog with its head out of a car) and a static pressure (obtained from a static port, more on that next slide), we can find easily your airspeed!

$$11. \text{Airspeed} = \sqrt{\frac{Dynamic\ Pressure}{0.5 * (Air\ Density)}} = \sqrt{\frac{(Total\ Pressure) - (Static\ Pressure)}{0.5 * (Air\ Density)}}$$

TOTAL PRESSURE (DOG FEELS THE WIND SPEED + AMBIENT PRESSURE)



STATIC PRESSURE (DOG FEELS AMBIANT PRESSURE ONLY)



PART 13 – TRAINING AND FAILURE SIMULATION

THE IMPORTANCE OF INSTRUMENTS

- A pitot tube is usually fit on the wings, which is where there is the most airflow to get the most accurate measurement of total pressure possible (since you need to be aligned with the moving fluid).
- A static port is a pressure sensor that needs to be placed in a particular place in order to measure a proper “static pressure” (which means in an area undisturbed by wind, undisturbed by dynamic effects). This means that the static port must be placed in a way that the sensor is perpendicular to the wind (and will not feel its pressure effect).

INSTRUMENT	NEEDS STATIC PRESSURE (STATIC PORT)	NEEDS TOTAL PRESSURE (PITOT TUBE)
Airspeed	X	X
Altimeter	X	
Variometer	X	

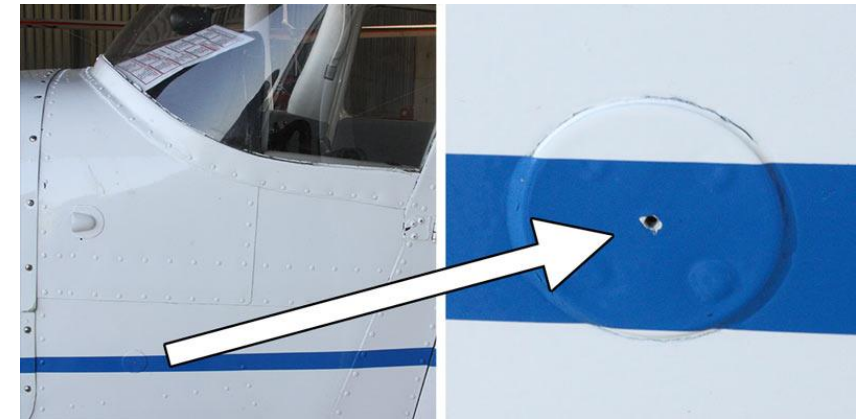
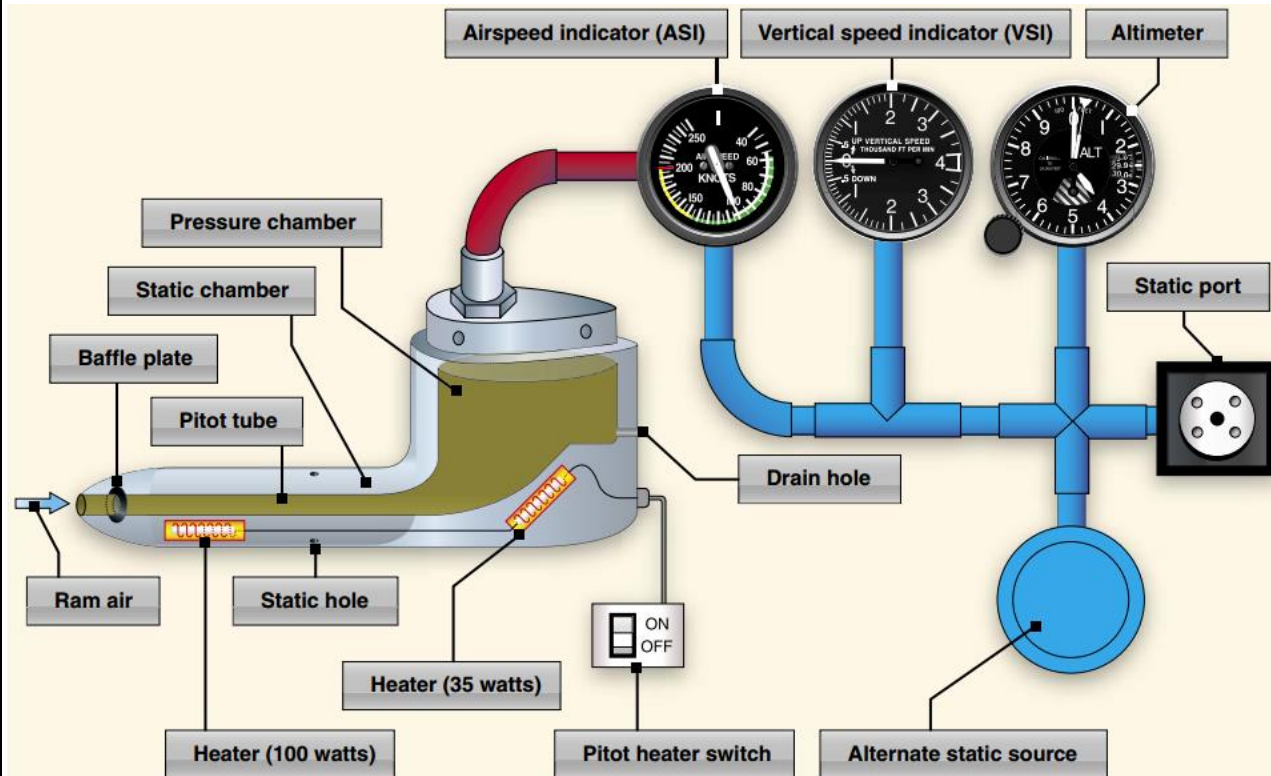
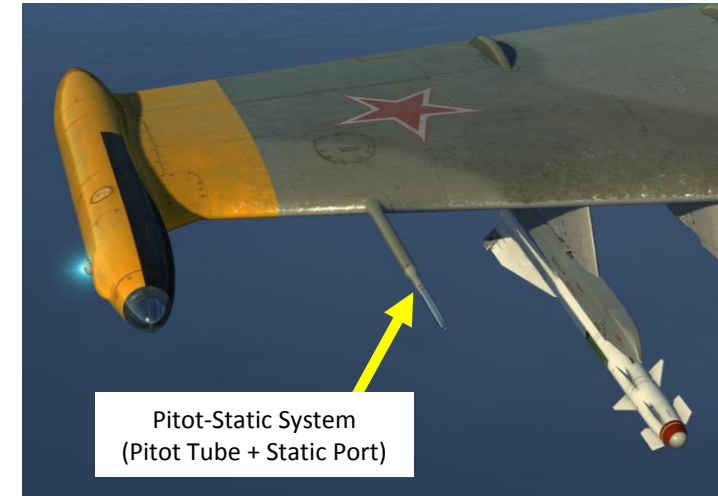

The static port pressure sensor will feel the pressure of the air laterally (or from the side of the aircraft), but will not feel the dynamic pressure created by the motion of the aircraft. See the “dog in car” analogy from previous page. 81

PART 13 – TRAINING AND FAILURE SIMULATION

THE IMPORTANCE OF INSTRUMENTS

- Static and Total Pressure failures can be simulated in the instructor's rear cockpit.
- A student pilot can recognize a **static pressure failure** if his **altimeter** and **variometer** readings are all "frozen". The airspeed indicator will still function, but will use a "frozen" static pressure reference value, which will give you an **incorrect airspeed reading as you change altitude**.
- A student pilot can recognize a **total pressure failure** if his **airspeed** reading is "frozen".
- **Corrective actions include:**
 1. Ensure Pitot Heat is ON (sensor could be blocked by ice) for selected pitot-static system
 2. Switch to standby pitot-static system as a backup

Figure 106: Pitot-static system

1. Primary pitot-static tube
2. Backup pitot-static tube
3. Primary/Backup pitot tube selector valve
4. Front cockpit gauges
5. Rear cockpit gauges
6. Pitot fault simulator valves
7. ISKRA-K unit airspeed sensor
8. ISKRA-K unit airspeed sensor
9. Front cockpit ejection seat speed pressure indicators
10. Rear cockpit ejection seat speed pressure indicators
11. Speed sensor
12. SARPP-12GM FDR speed and automatic activation sensor
13. Speed signalization in flap control sensor circuit
14. Cockpit pressure regulators
15. ASP-3NMU "altitude mechanism"

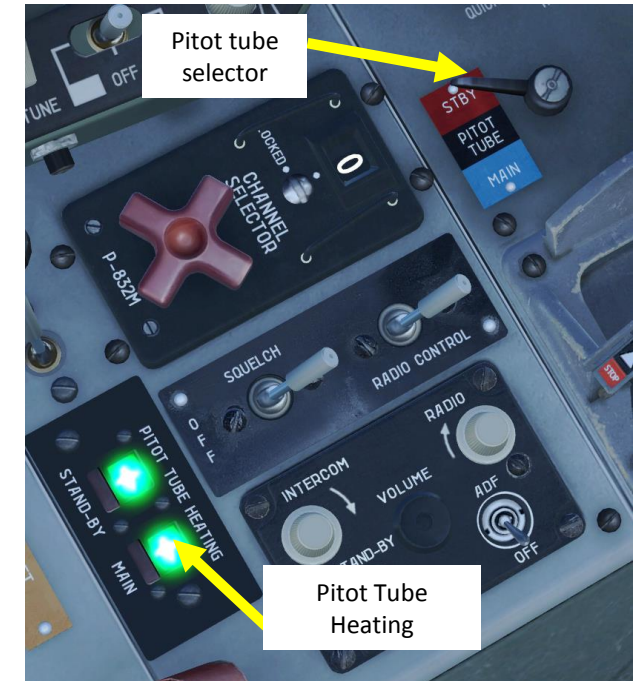
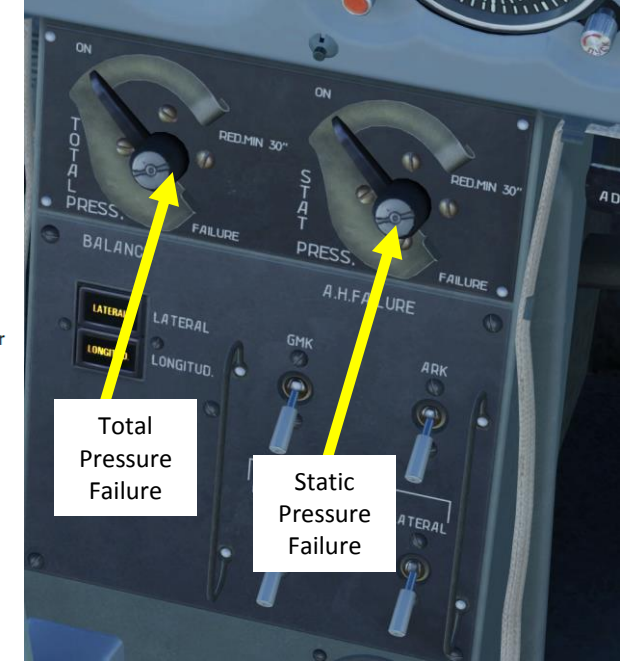
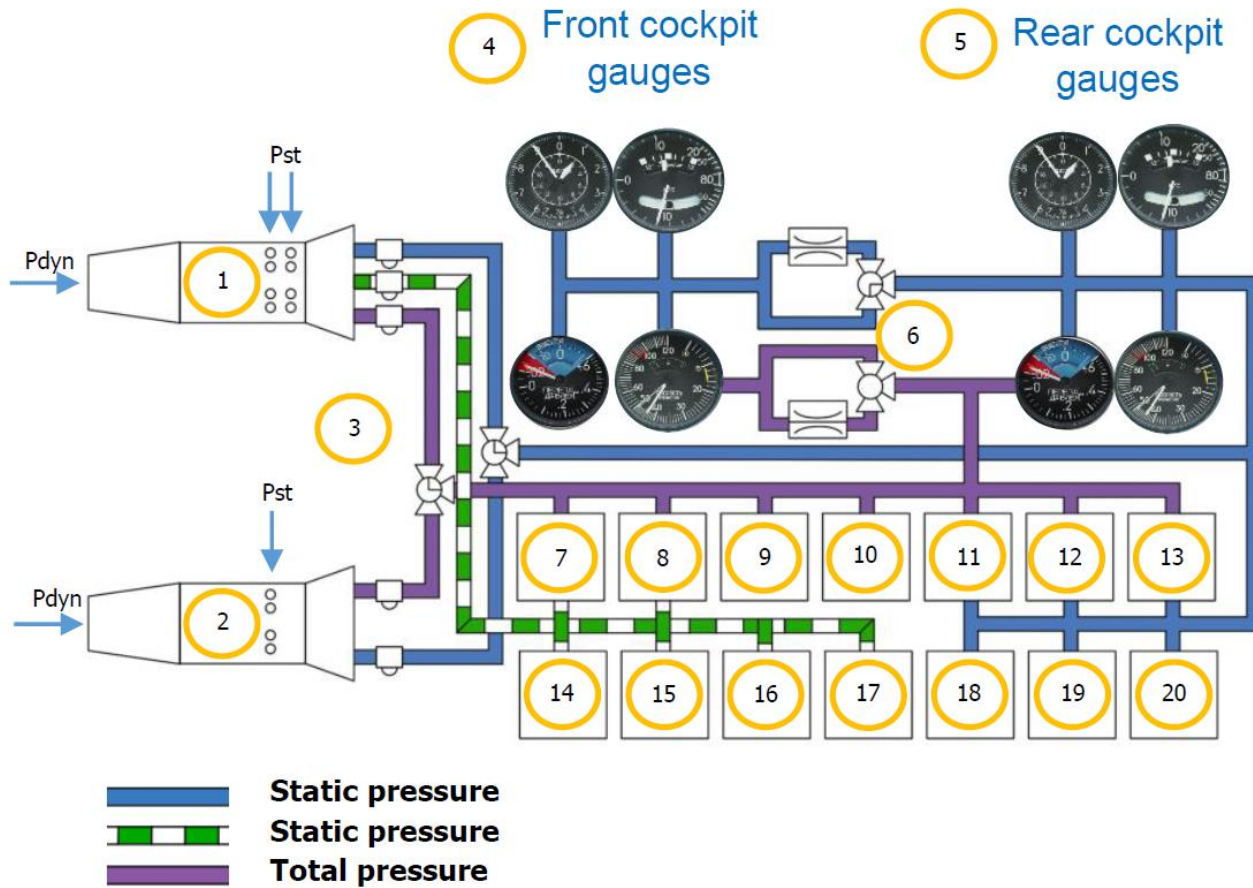

RESOURCES

DCS L-39 Flight Manual

<https://drive.google.com/open?id=0B-uSpZROuEd3QIJ6NEpBbTFWXzQ>

Aero L-39C Flight Manual

<http://www.anythingaboutaviation.com/wp-content/uploads/2013/01/Aero-L-39-Flight-Manual.pdf>

Dangerous Passion – L-39 Experience Documentary

PART 1 - <https://www.youtube.com/watch?v=-0tvPUQxl4c>

PART 2 – <https://www.youtube.com/watch?v=3wFGcQ95SM>

PART 3 – <https://www.youtube.com/watch?v=0EzO0MM4ITY>

XXJOHNXX's Youtube Tutorials

<https://www.youtube.com/watch?v=OE-VT7XPm0s&list=PLxM0tbYYV7hKUQRflllvCHjeYvN62x2x>

BEASTYBAITER's Youtube Tutorials

https://www.youtube.com/watch?v=GBSO3Ht3u1g&list=PLXatIJ39zMX7FZIQDI-P_HZRp5EW0IJ4v

L-39 ALBATROS



- INSTANT ACTION
- CREATE FAST MISSION
- MISSION
- CAMPAIGN
- MULTIPLAYER

- LOGBOOK
- ENCYCLOPEDIA
- TRAINING
- REPLAY

- MISSION EDITOR
- CAMPAIGN BUILDER

EXIT

A-10C 1.5.3	Bf 109 K-4 1.5.3 beta	C-101 1.5.3 Beta	CA 1.5.3	F-86F 1.5.3	FC3 1.5.3	Fw 190 D-9 1.5.3	Hawk 1.5.3 Beta	Ka-50 1.5.3	L-39 1.5.3	M-2000C 2.0.0 Beta	Mi-8MTV2 1.5.3 beta	MiG-15bis 1.5.3	MiG-21bis 1.5.3	P-51D 1.5.3	Su-25T 1.5.3	TF-51 1.5.3	UH-1H 1.5.3